

TT 350 S > 15A-BA--650 (2015) > GRUNDGERÄT

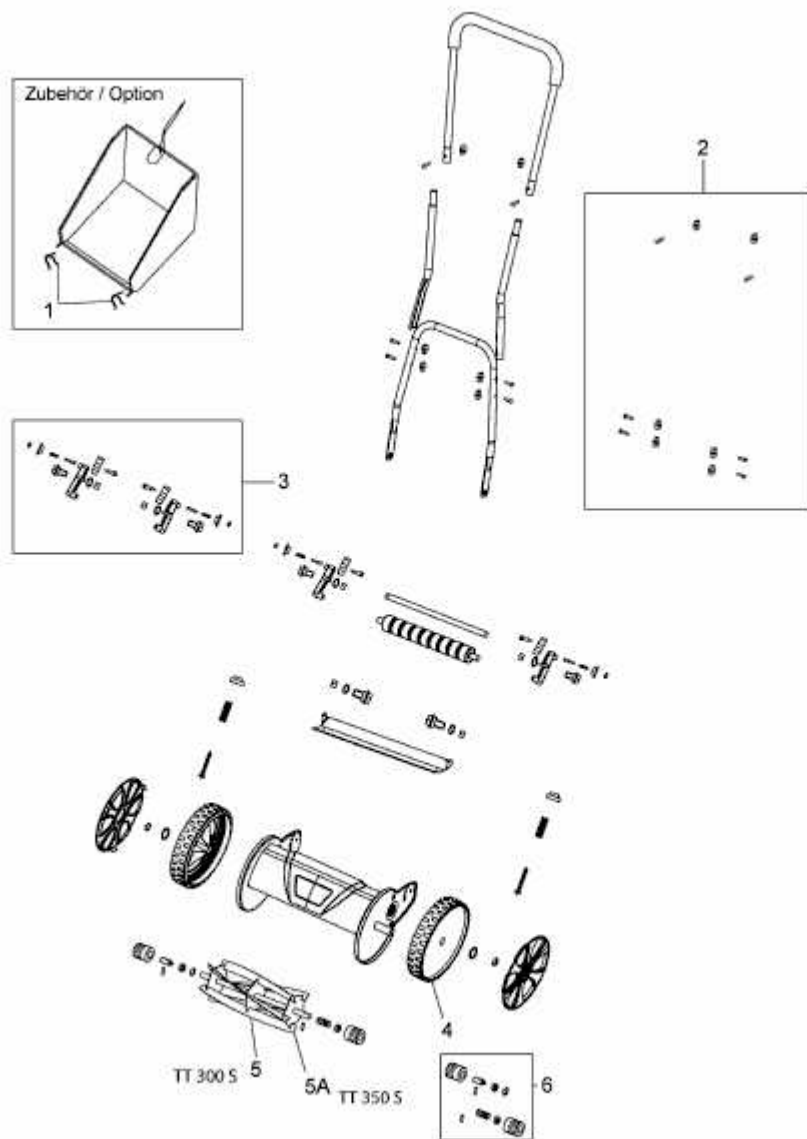

E3-06013B-01