

TT 300 S > 15A-AA--650 (2015) > GRUNDGERÄT

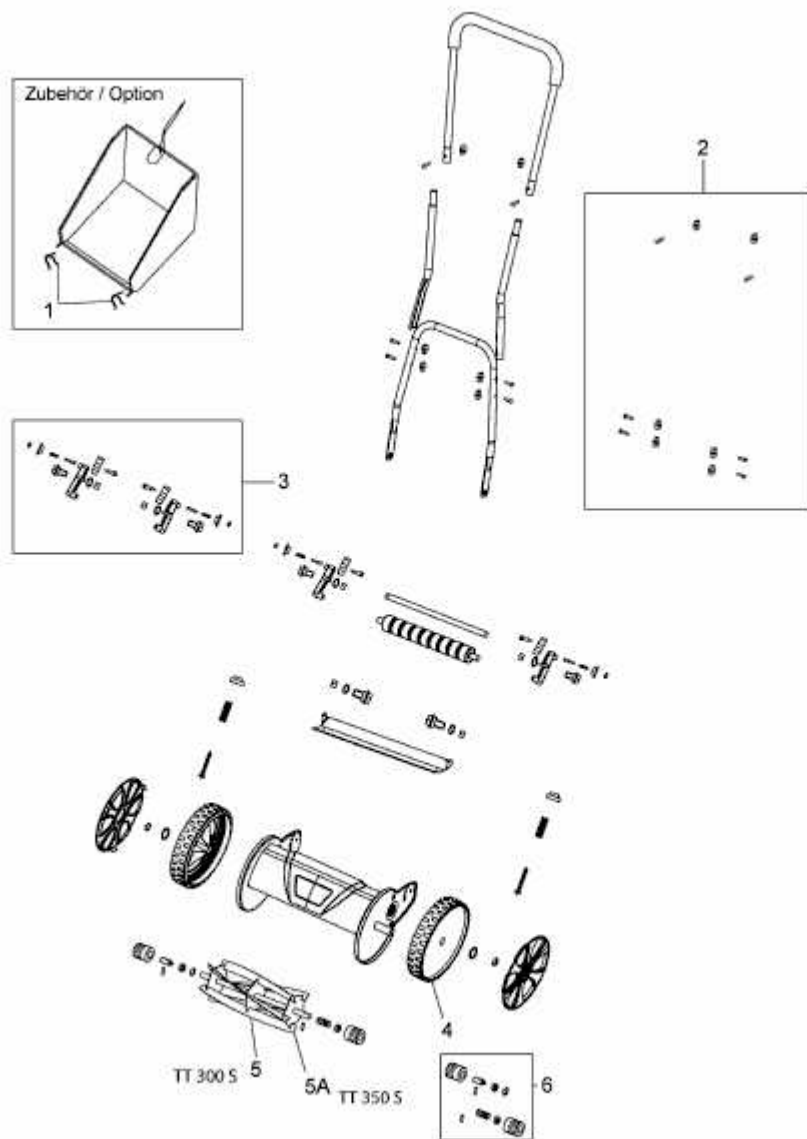

E3-06013B-01