

ab 01.06.2015
from 01.06.2015
à partir du 01.06.2015

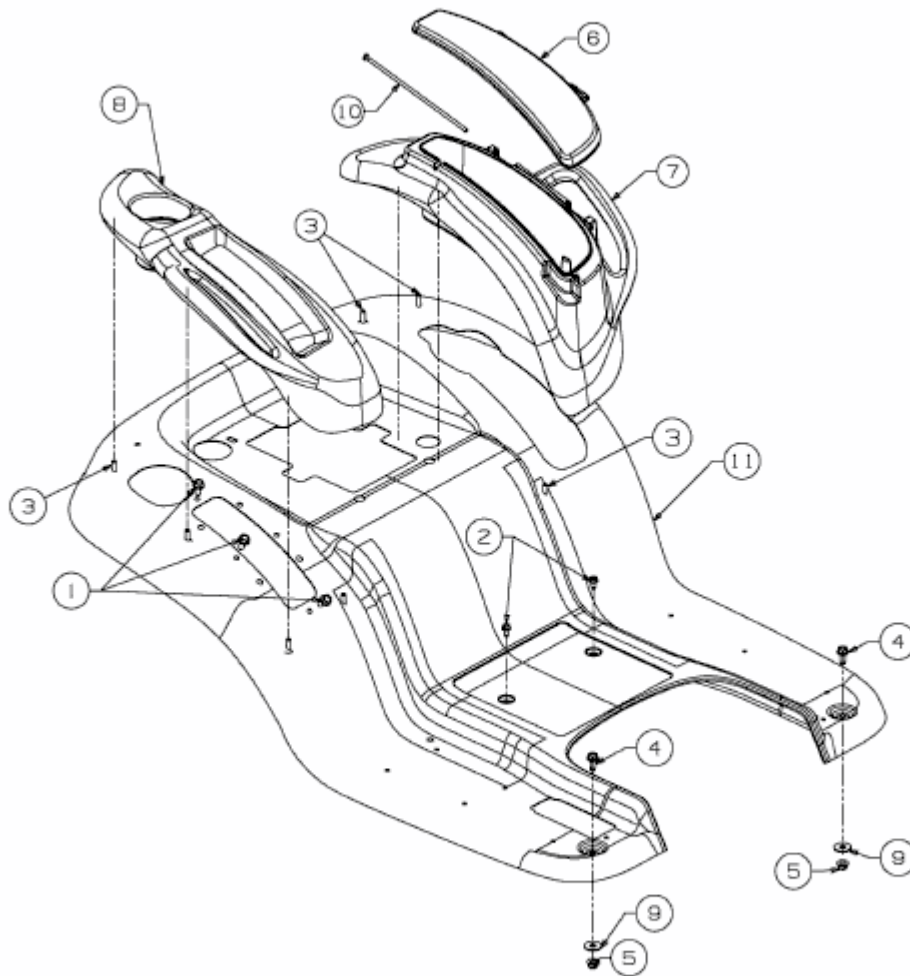

E3-02841A-02