

ab 01.06.2015  
from 01.06.2015  
à partir du 01.06.2015

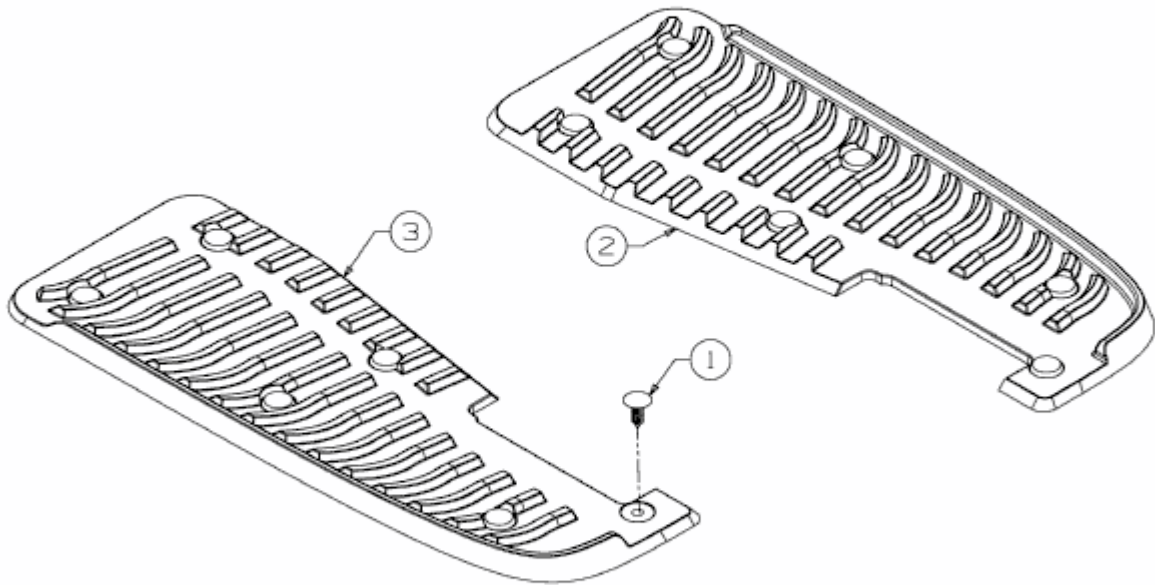

E3-07338A-02