

ab 19.09.2003
 from 19.09.2003
 à partir du 19.09.2003

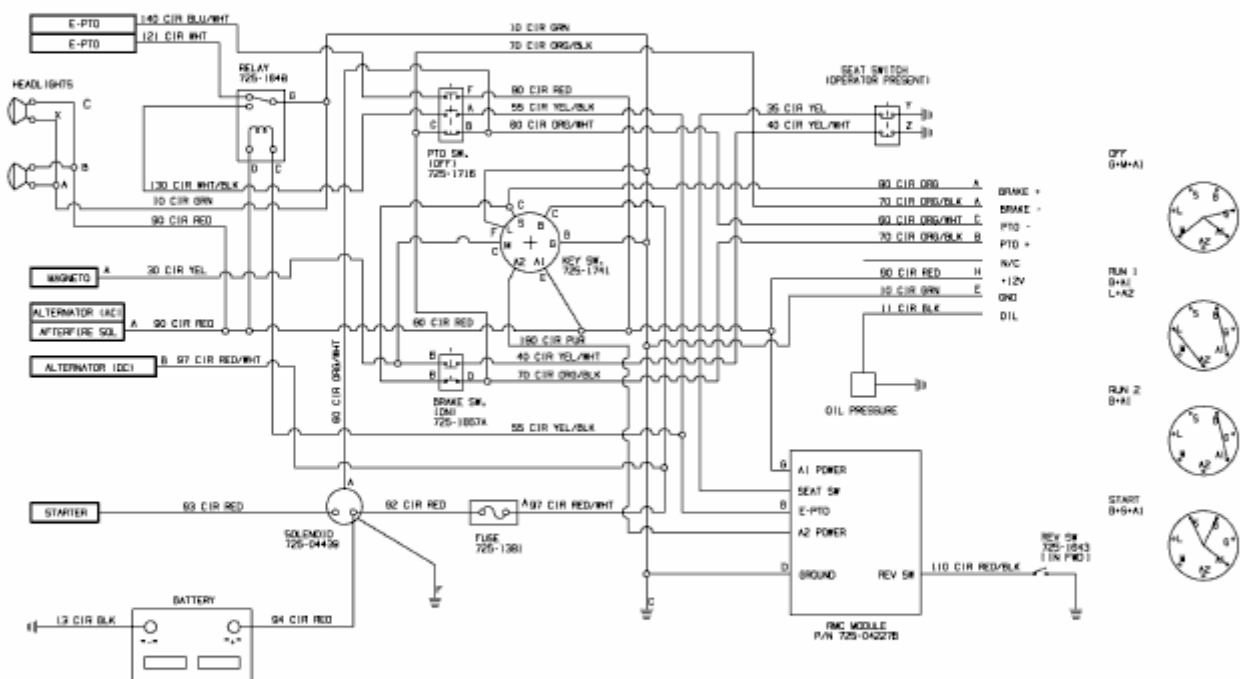

E3-07948A-02