

ab 16.10.2003
from 16.10.2003
à partir du 16.10.2003

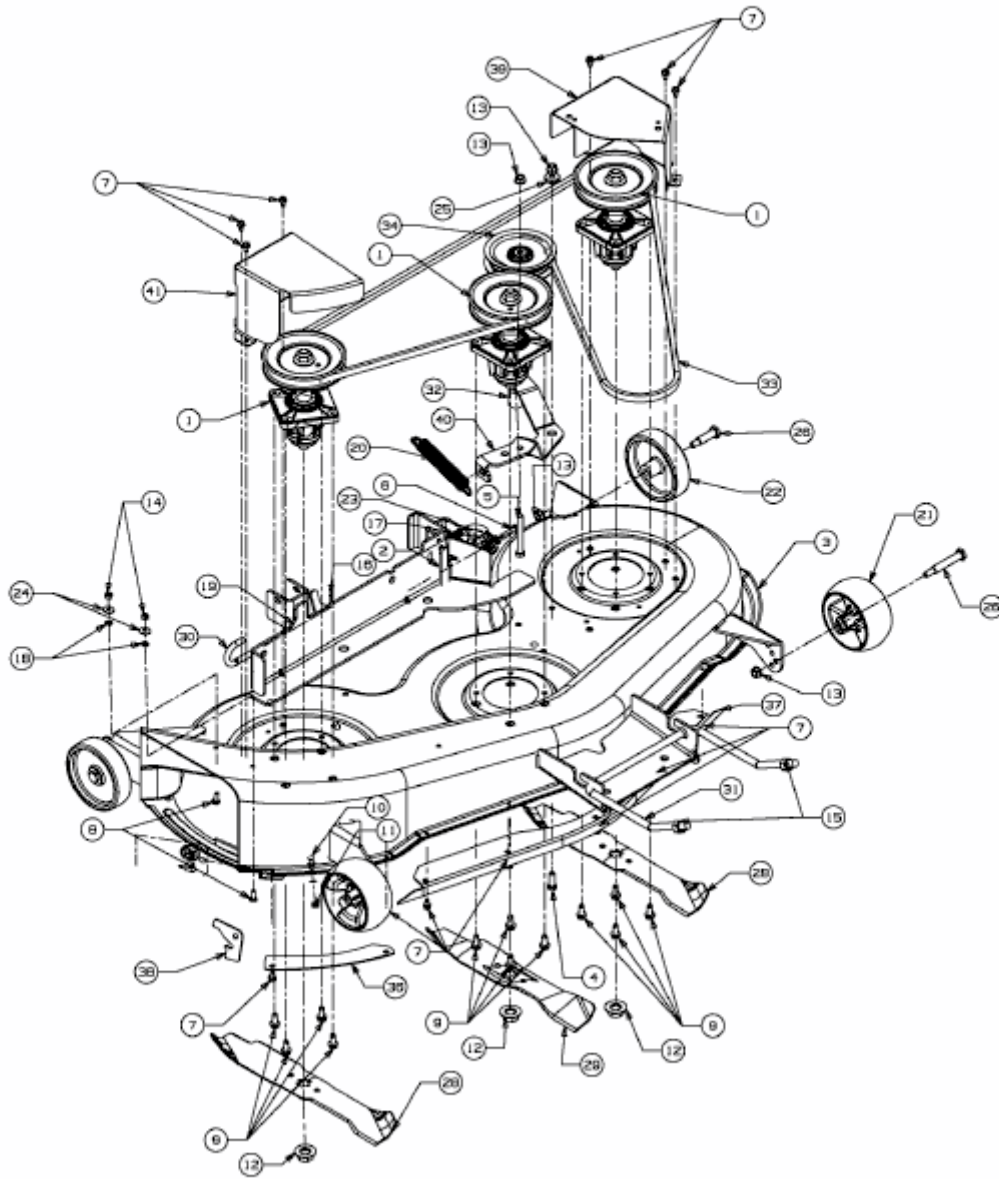

E3-07950A-01