

ab 19.09.2003
from 19.09.2003
à partir du 19.09.2003

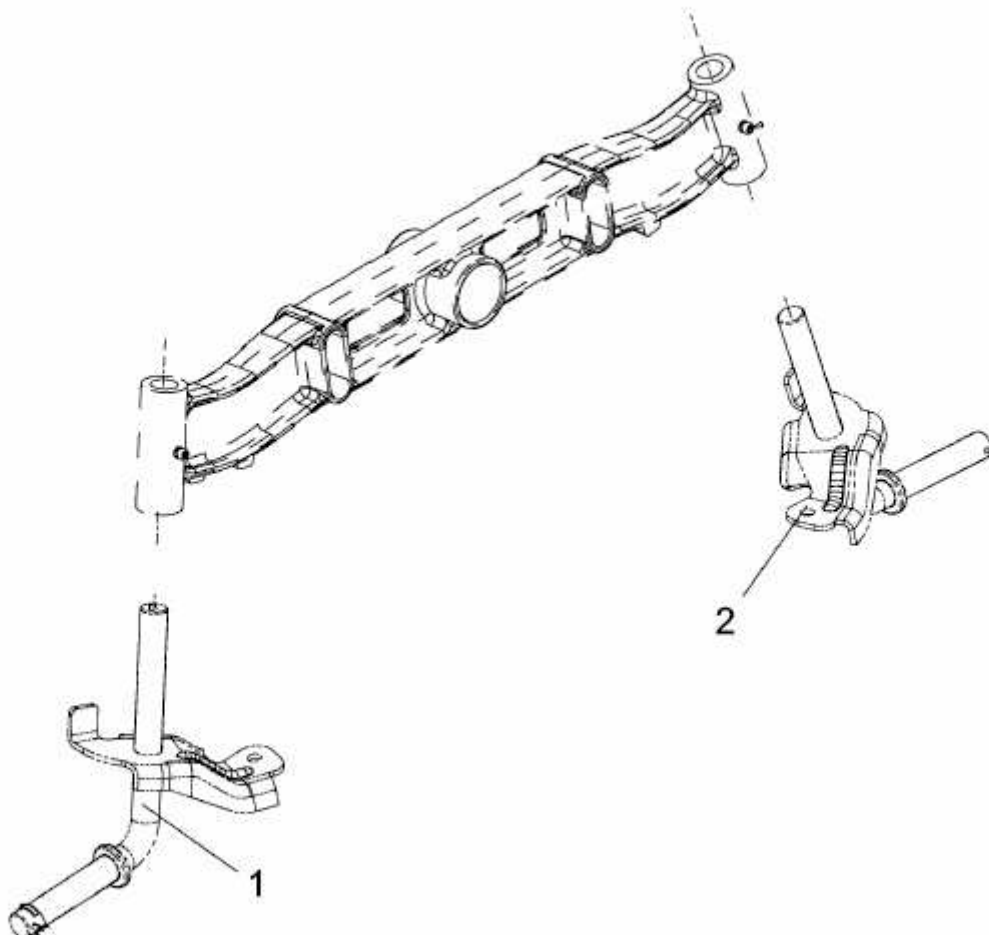

E3-02902A-02