

bis 19.09.2003
to 19.09.2003
jusqu'au 19.09.2003

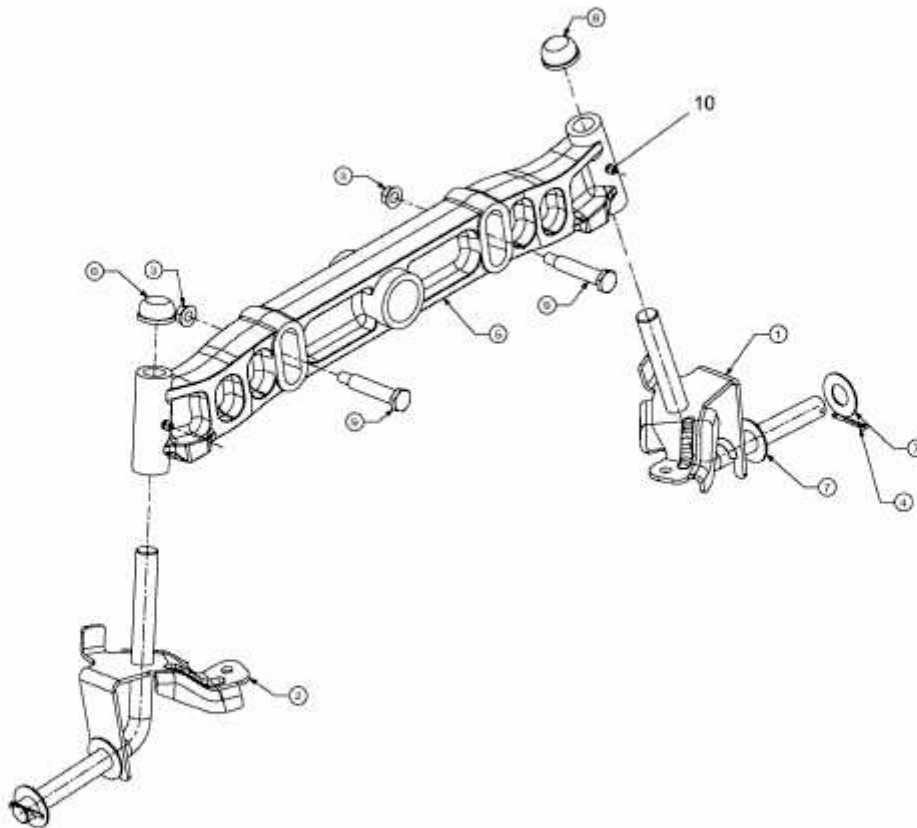

E3-07946A-01