

ab 15.10.2002
from 15.10.2002
à partir du 15.10.2002

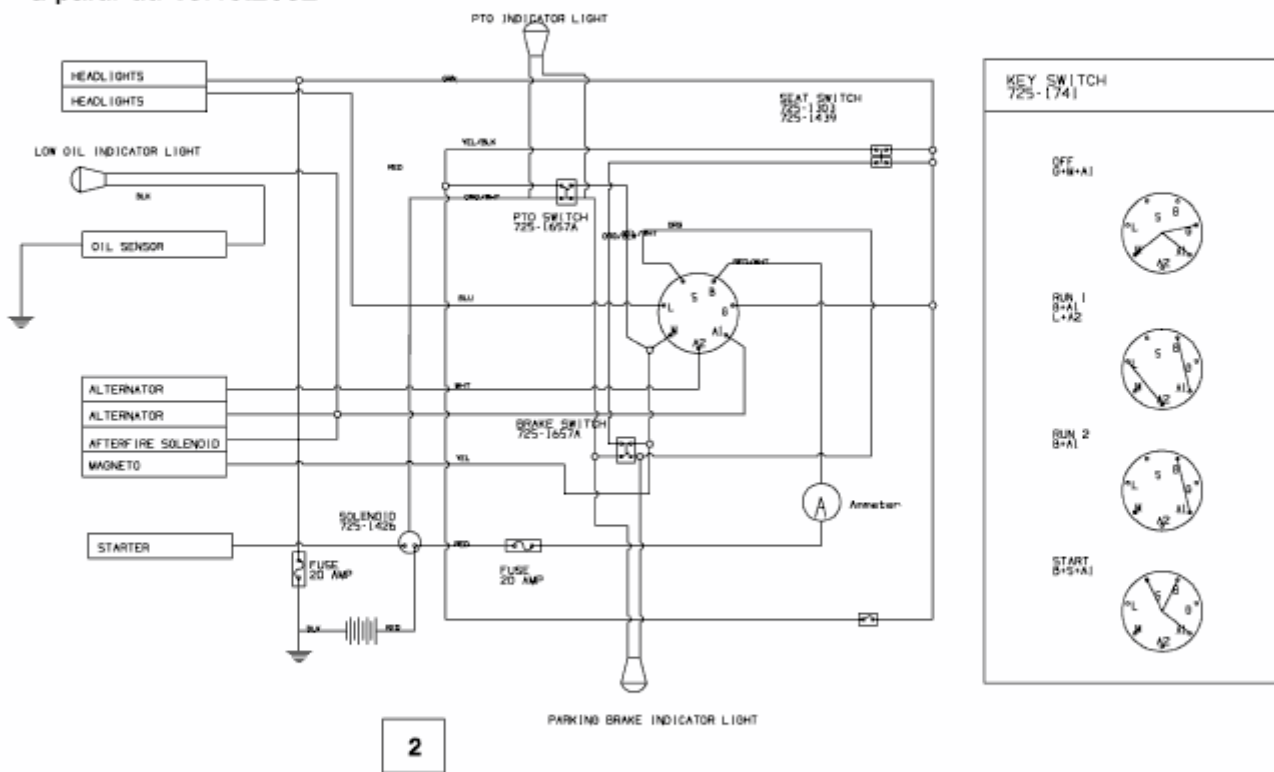

E3-05088A-02