

ab 06.10.2005
from 06.10.2005
à partir du 06.10.2005

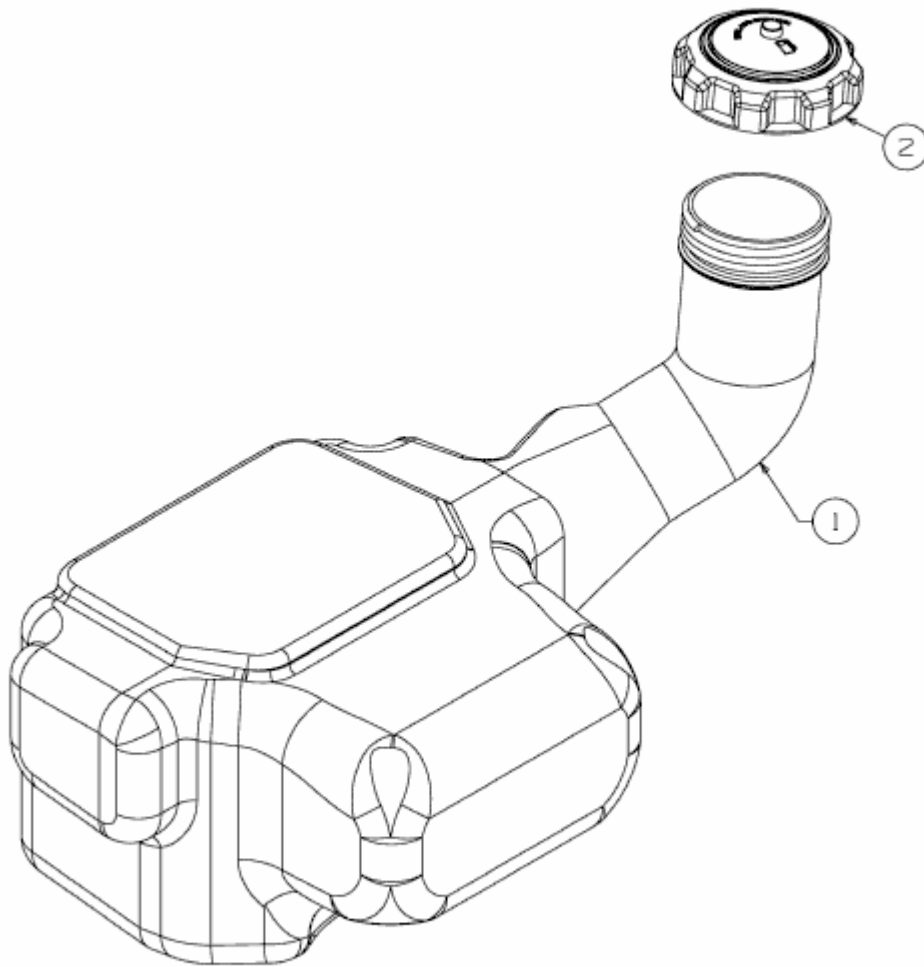

E3-03097A-02