

ab 11.10.2007
from 11.10.2007
à partir du 11.10.2007

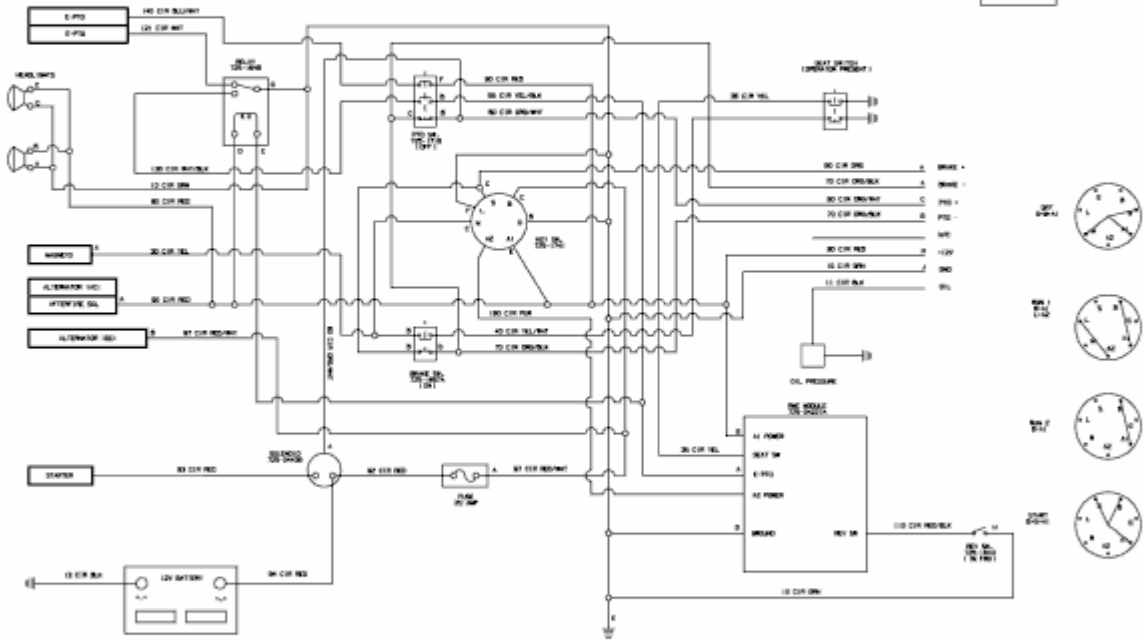

E4-02290B-02