

bis 18.10.2006
to 18.10.2006
jusqu'au 18.10.2006

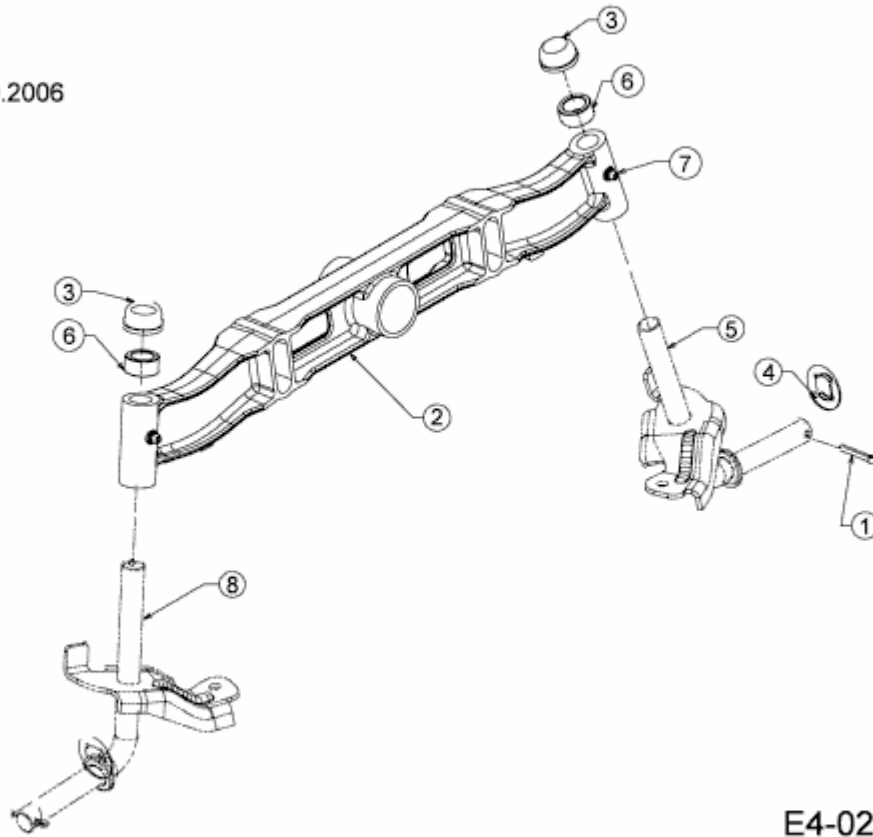

E4-02335A-01