

ab 01.05.2012
from 01.05.2012
à partir du 01.05.2012

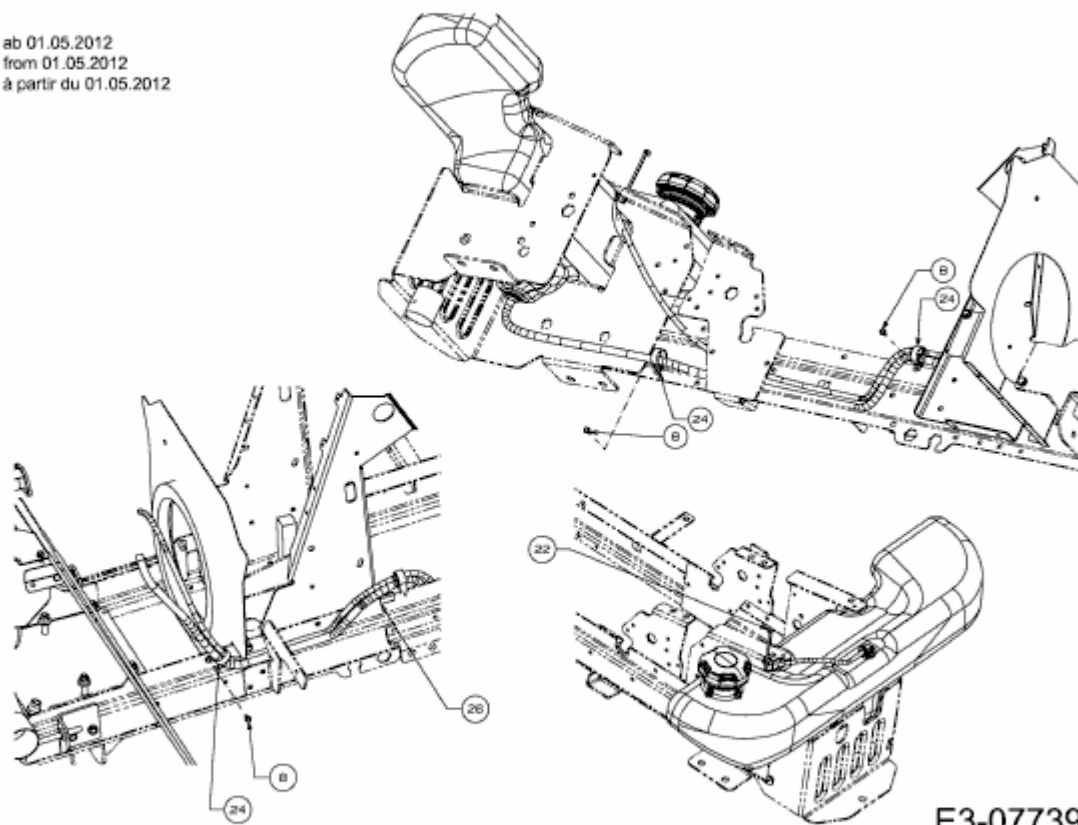

E3-07739A-02