

ab 07.11.2007
from 07.11.2007
à partir du 07.11.2007

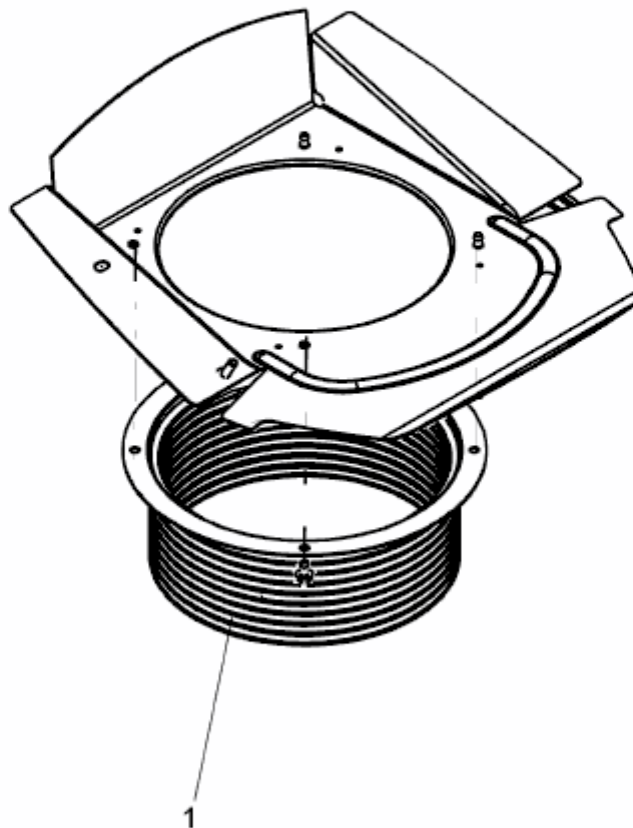

E3-02247A-01