

ab 19.05.2014  
from 19.05.2014  
à partir du 19.05.2014

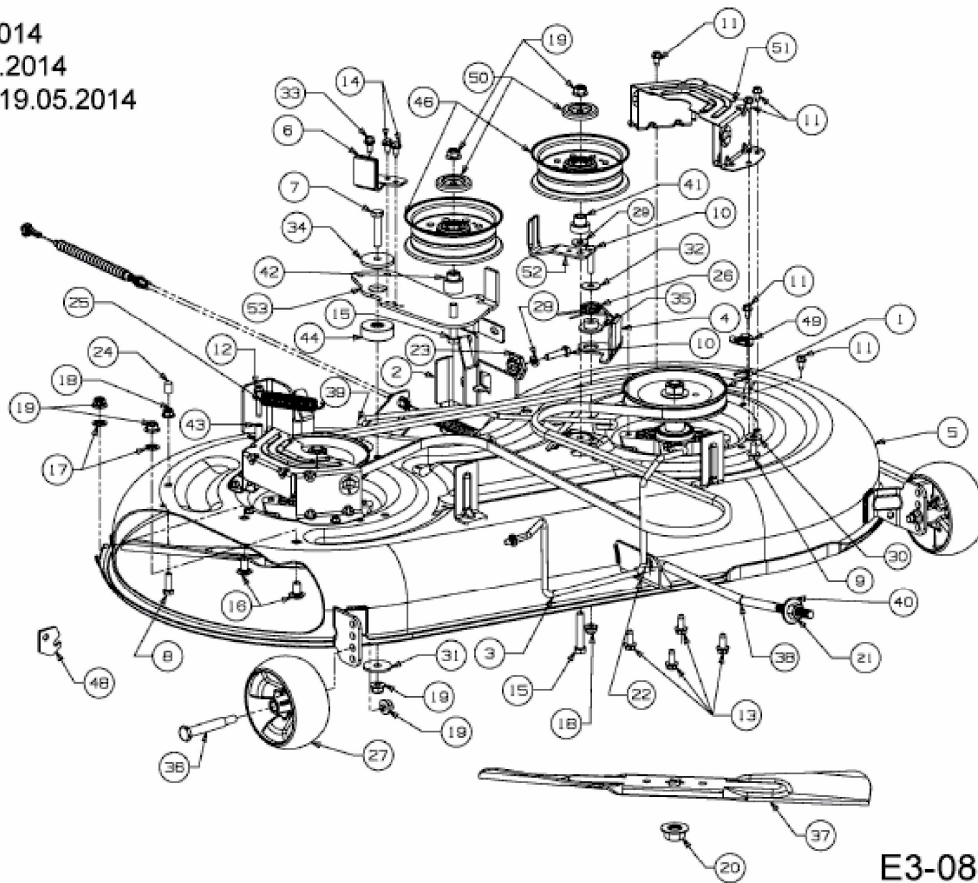

E3-08734A-01