

ab 01.05.2013
from 01.05.2013
à partir du 01.05.2013

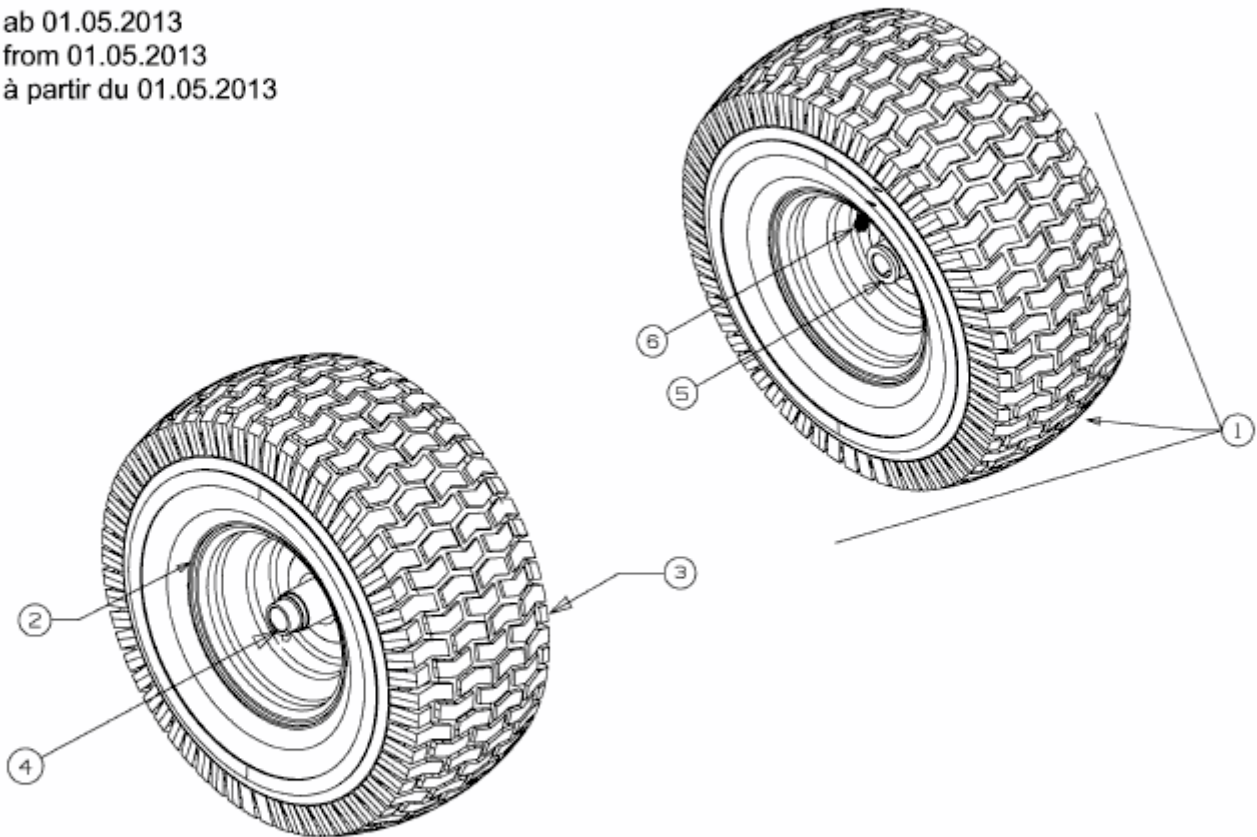

E3-02085B-03