

ab 27.01.2012  
from 27.01.2012  
à partir du 27.01.2012

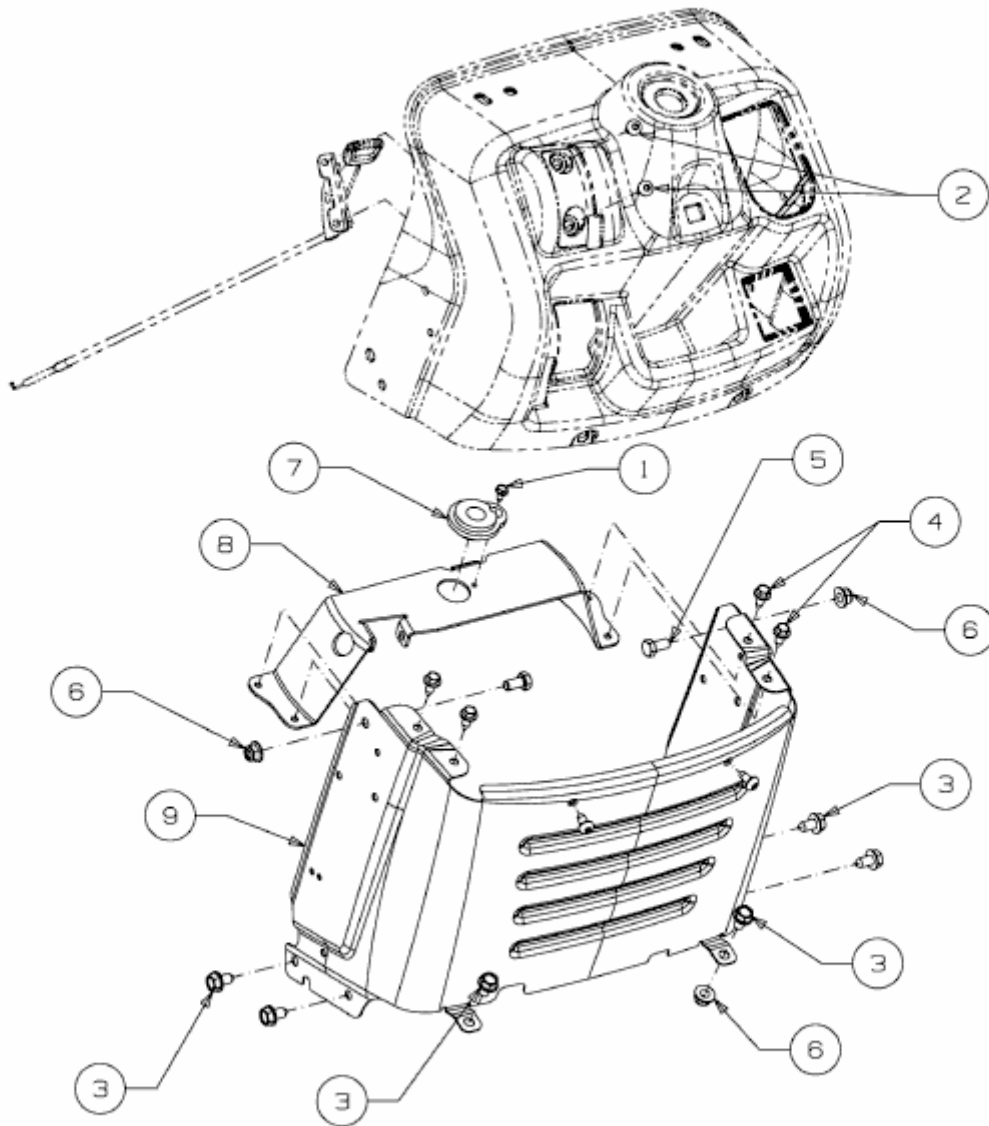

E3-07428A-03