

ab 27.01.2012
from 27.01.2012
à partir du 27.01.2012

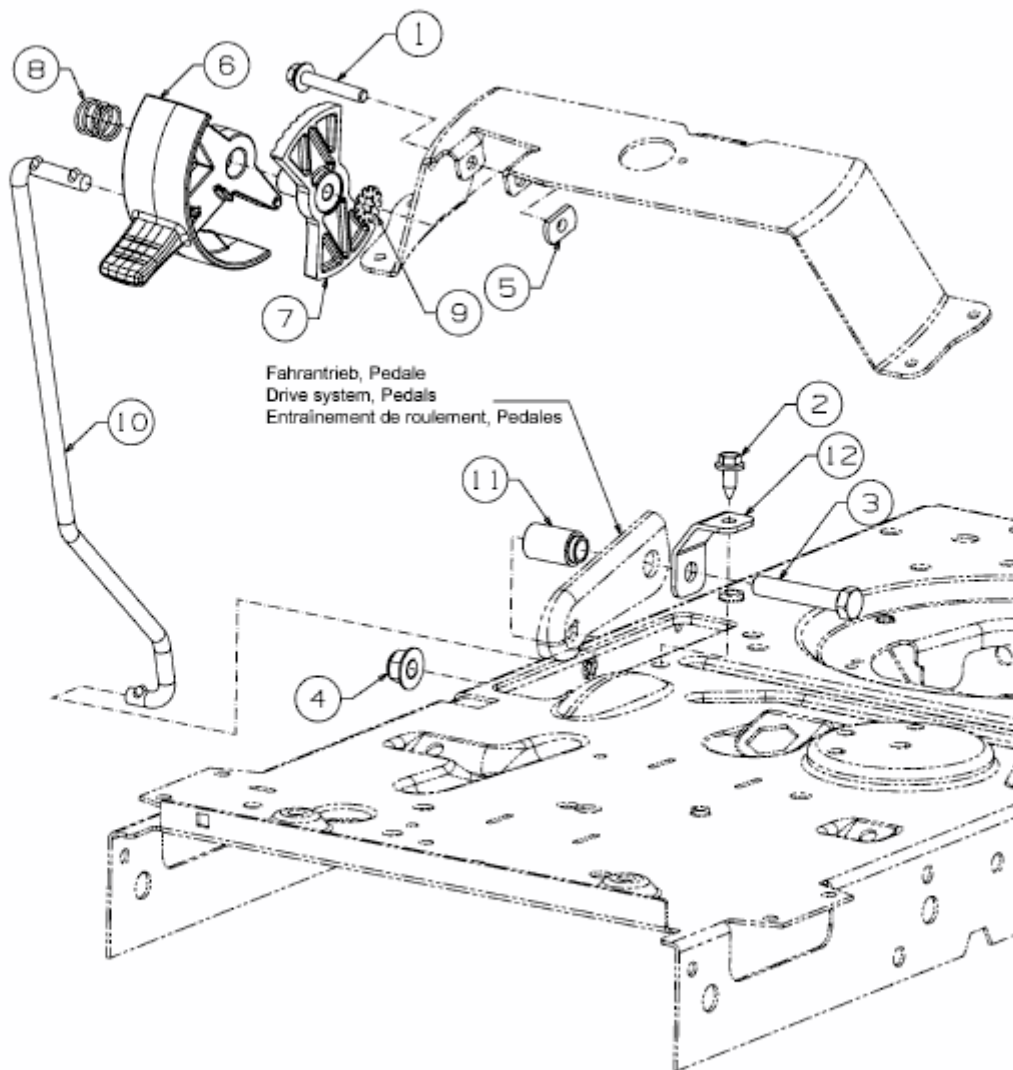

E3-07438A-02