

CC 1024 RD-N > 13MI51AN603 (2011) > GRASFANGVORRICHTUNG

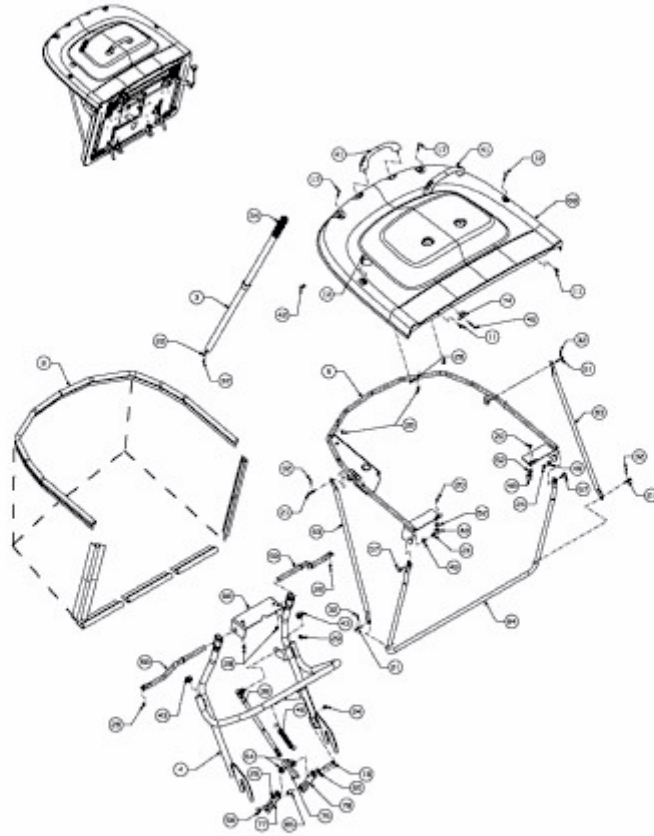

E3-06673A-01