

CC 1024 RD-N > 13MI51AN603 (2011) > ANHÄNGEKUPPLUNG, RAHMEN

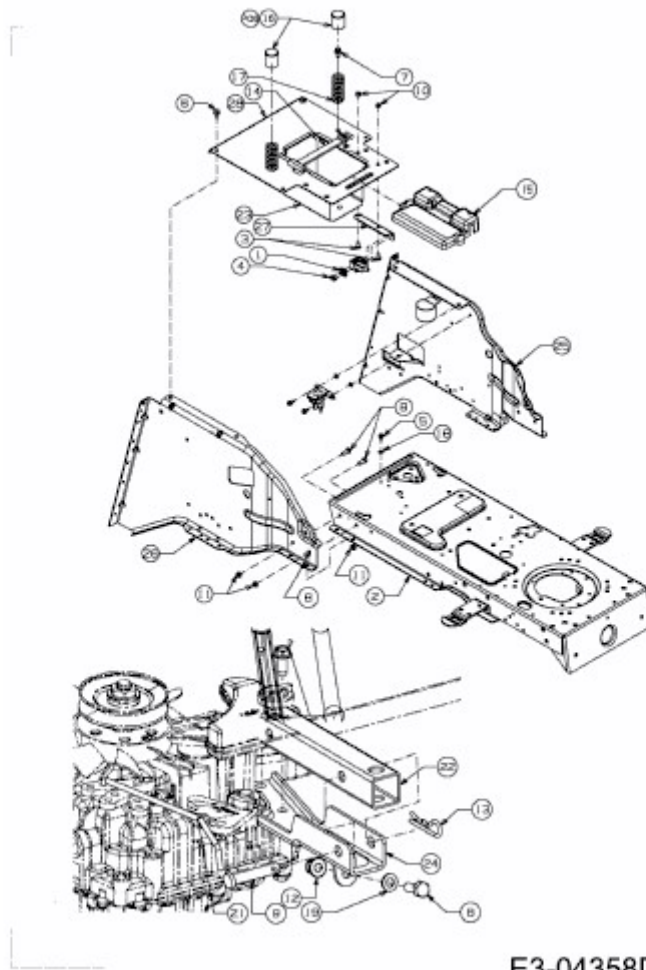

E3-04358D-01