

CC 1024 RD-N > 13MI51AN603 (2011) > TANK

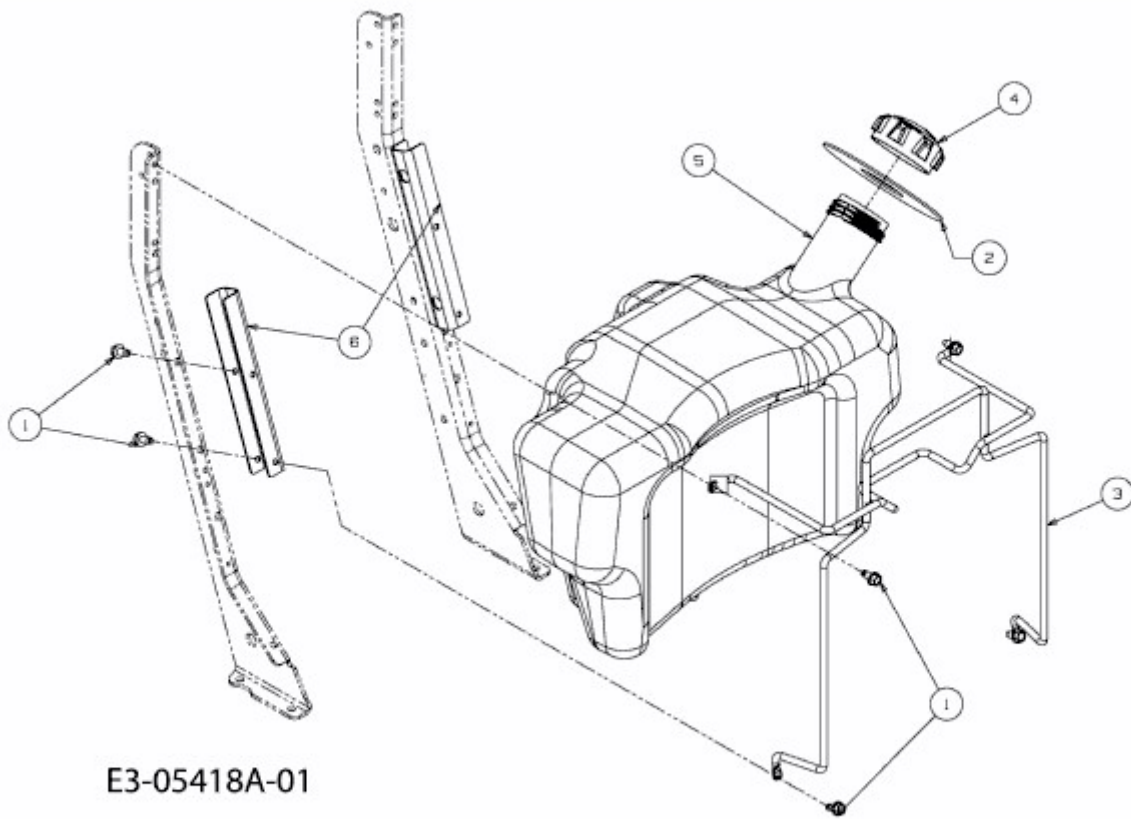

E3-05418A-01