

CC 1024 RD-J > 13MI51AJ403 (2011) > ANHÄNGEKUPPLUNG, RAHMEN

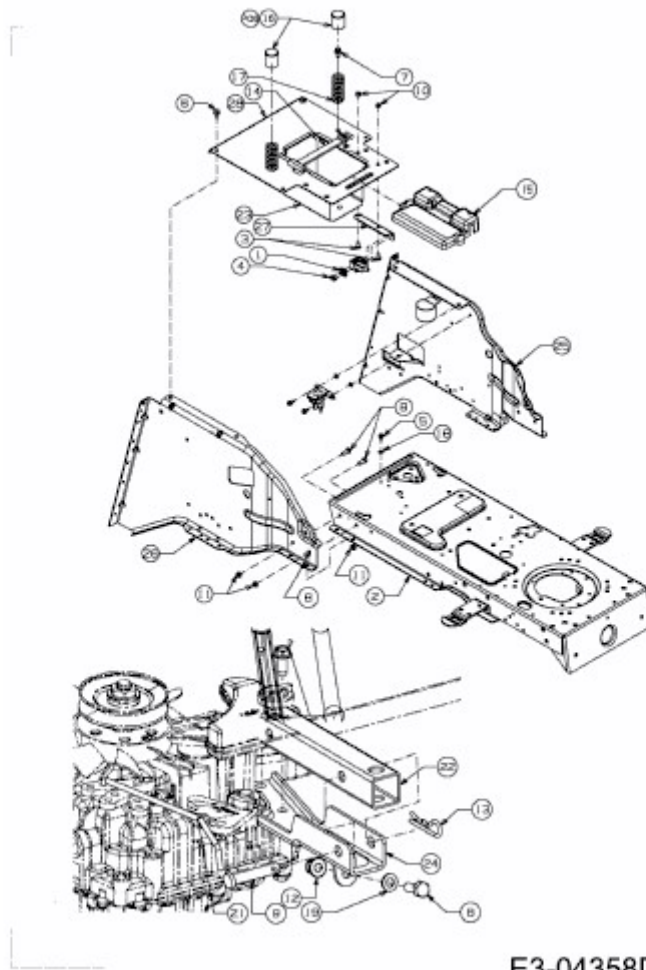

E3-04358D-01