

13MG51AE603 (2011) > ANHÄNGEKUPPLUNG, RAHMEN

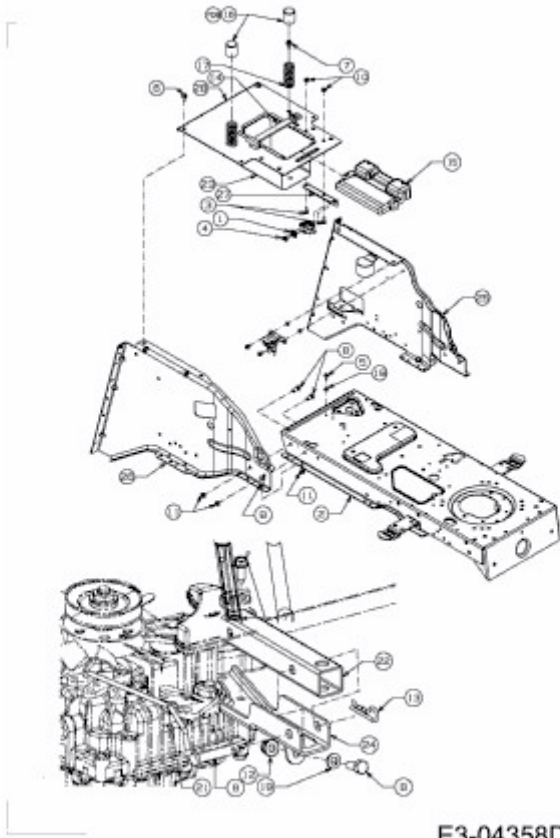

E3-04358D-01