

13MG51AE403 (2011) > GRASFANGVORRICHTUNG

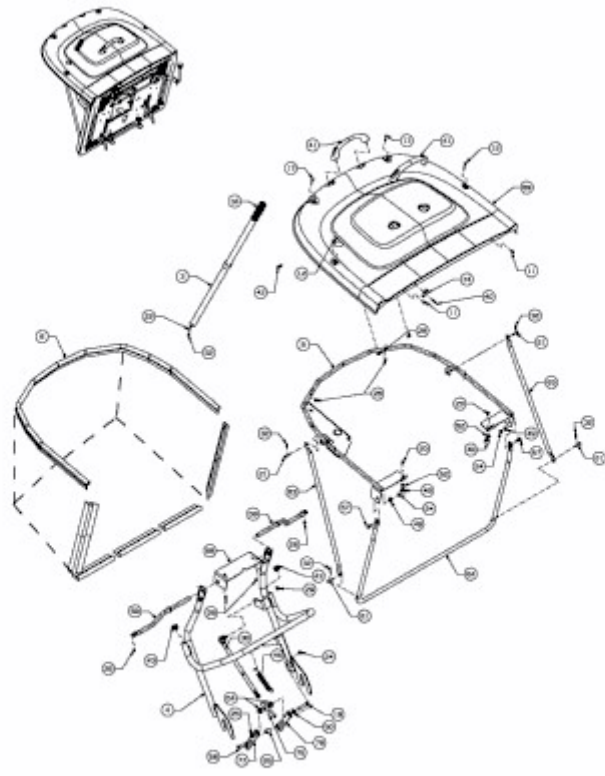

E3-06673A-01