

[LT 2 NS 96](#) > [131279DF603 \(2018\)](#) > [Motor MTD ab 07.11.2016](#)

ab 07.11.2016
from 07.11.2016
à partir du 07.11.2016

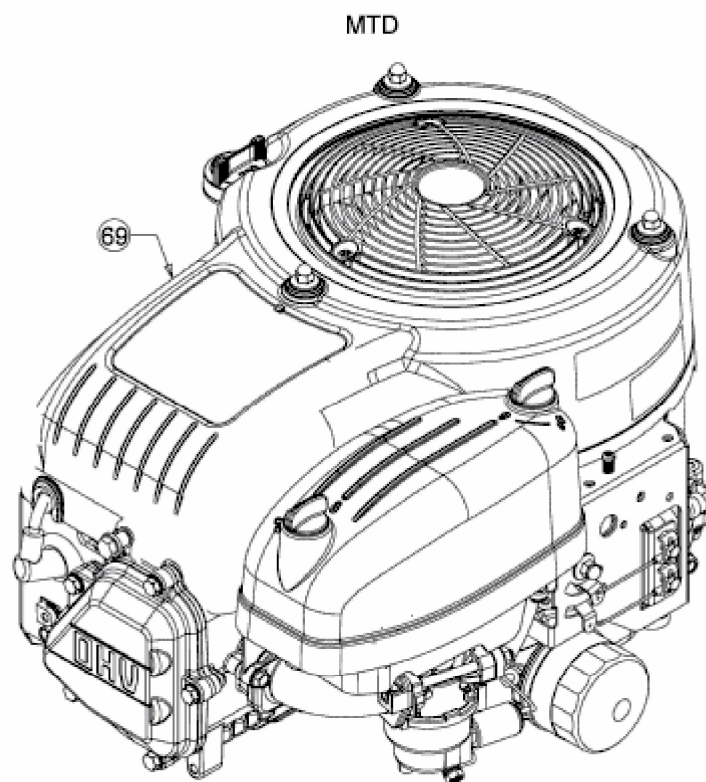

Model: 4 P 90 HUD

E3-10159A-02