

272-105 TWINH > 13HU997N615 (2015) > MOTOR BRIGGS&STRATTON AB 07.03.2014

ab 07.03.2014
from 07.03.2014
à partir du 07.03.2014

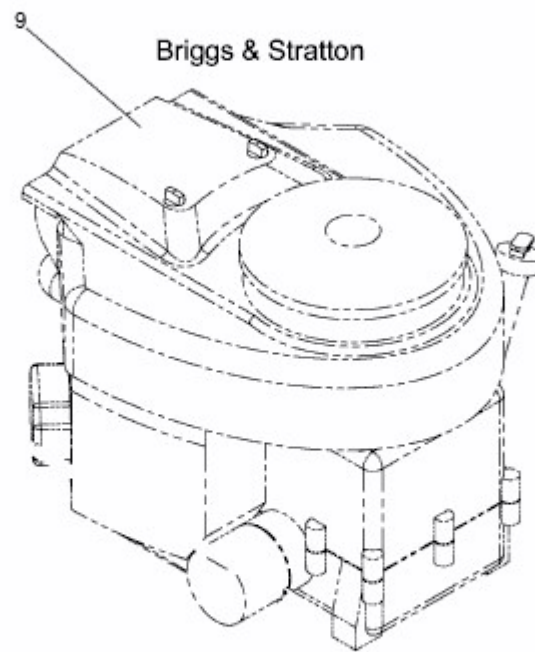

Model: 40R877
Type: 70012B1

E3-02472A-02