

272-105 TWINH > 13HU997N615 (2015) > AUSGLEICHSBEHÄLTER, HYDROSTAT

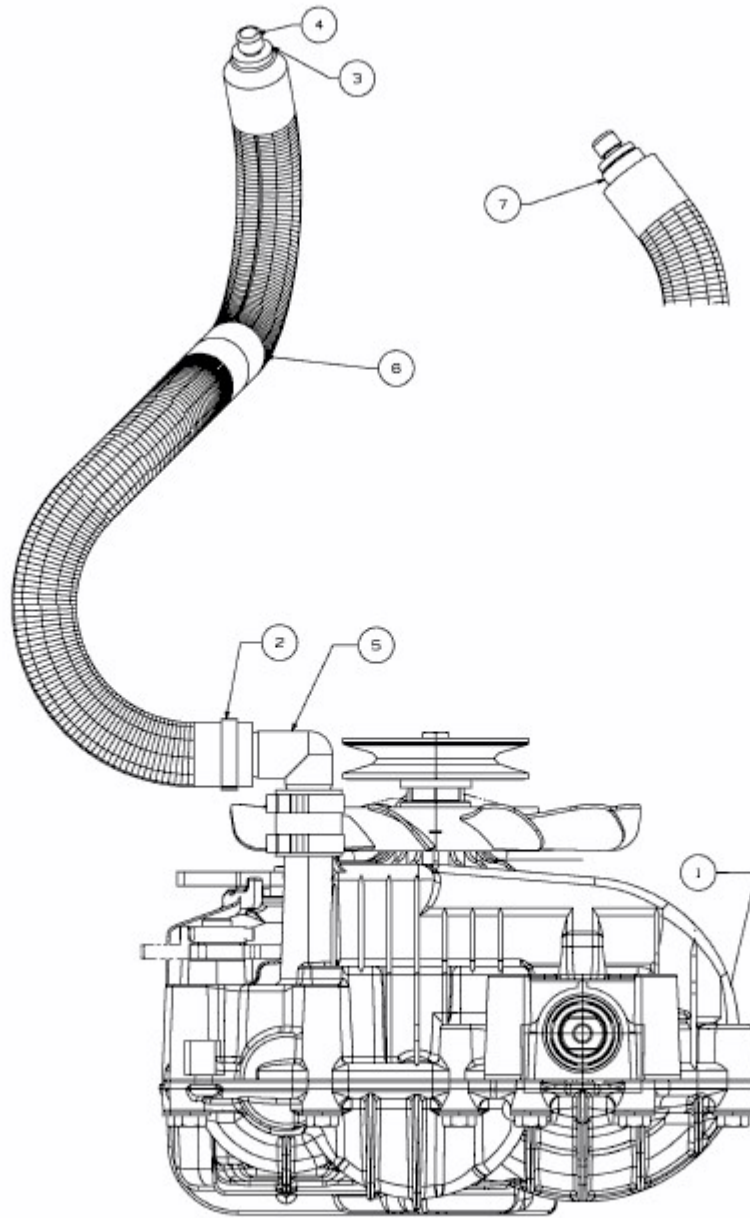

E3-07522C-02