

CC 1018 BHG > 13HT93AG603 (2015) > ELEKTROMAGNETKUPPLUNG,
MOTORKEILRIEMENSCHLEIBE

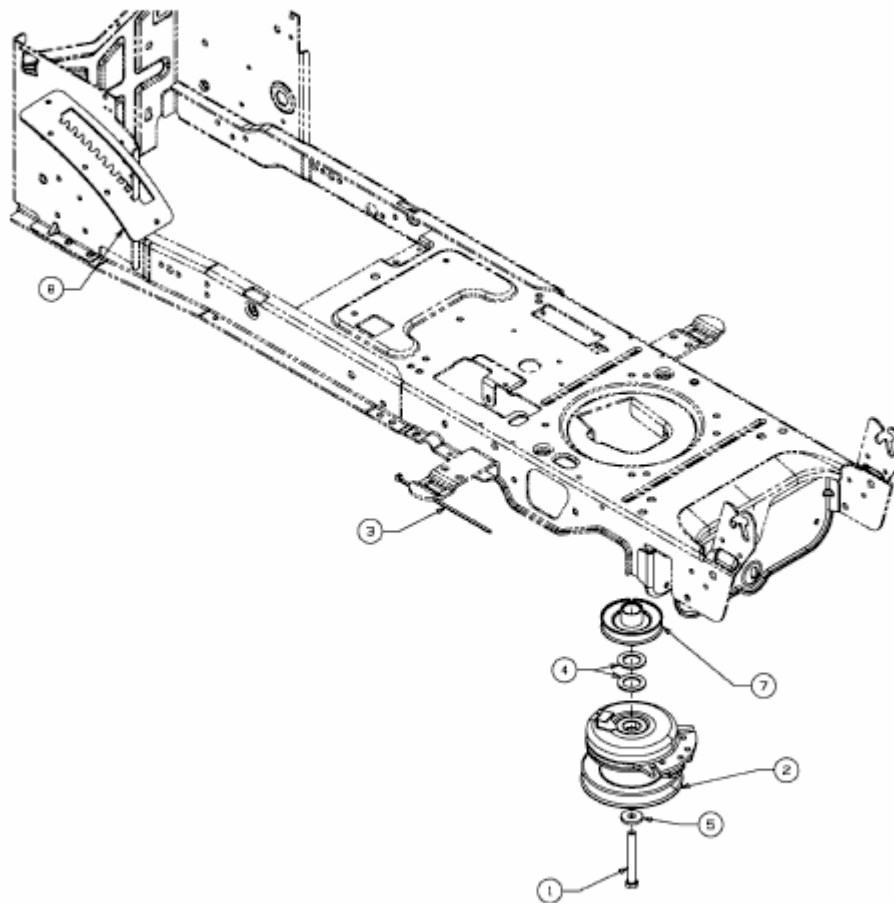

E3-04594C-01