

ab 07.01.2015
from 07.01.2015
à partir du 07.01.2015

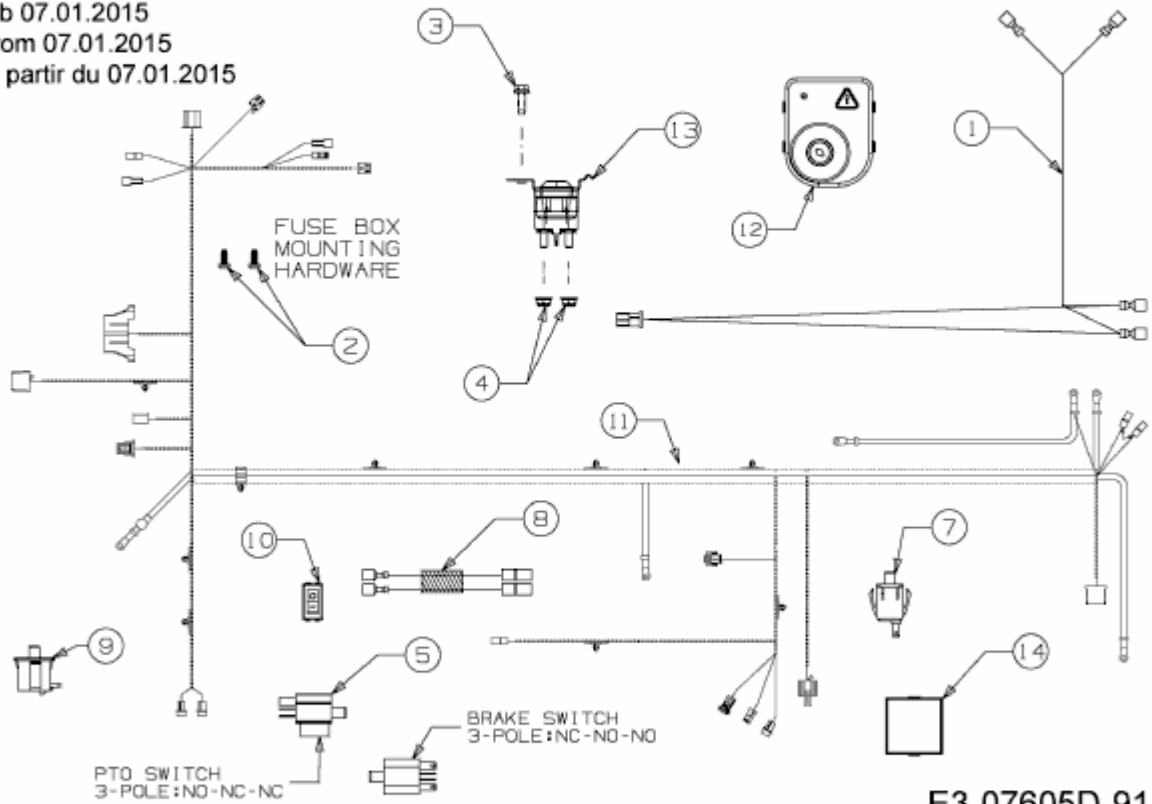

E3-07605D-91