

ab 14.04.2017  
from 14.04.2017  
à partir du 14.04.2017

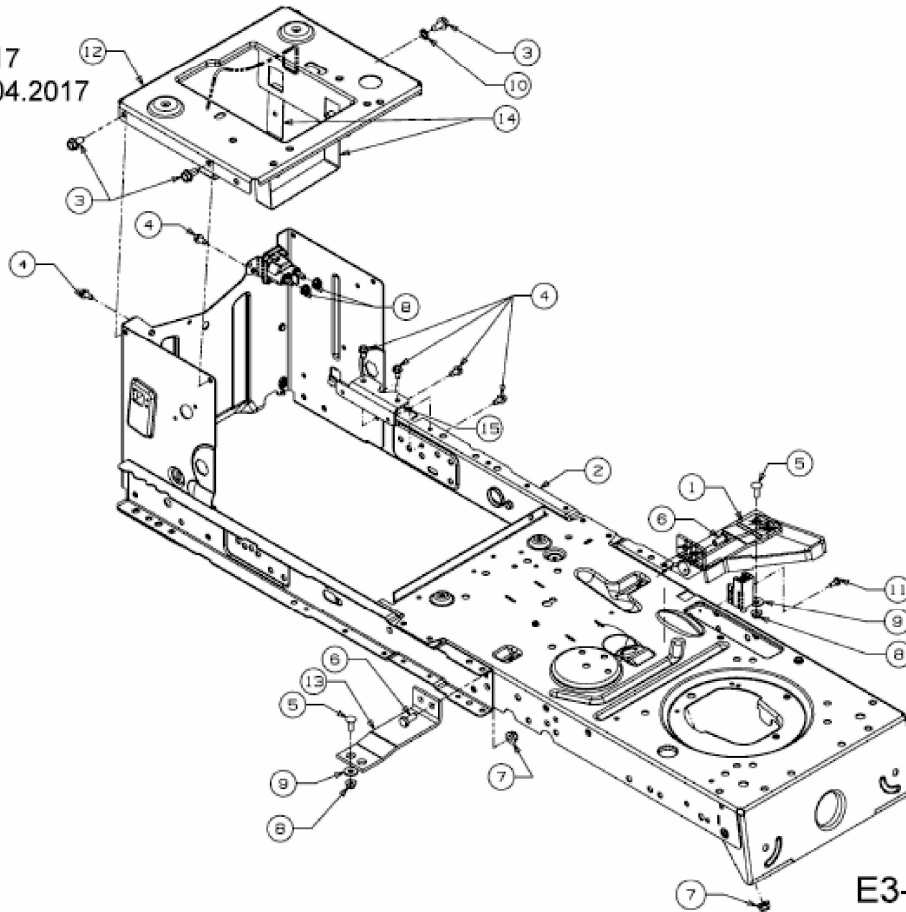

E3-10245A-01