

ab 26.03.2015  
from 26.03.2015  
à partir du 26.03.2015

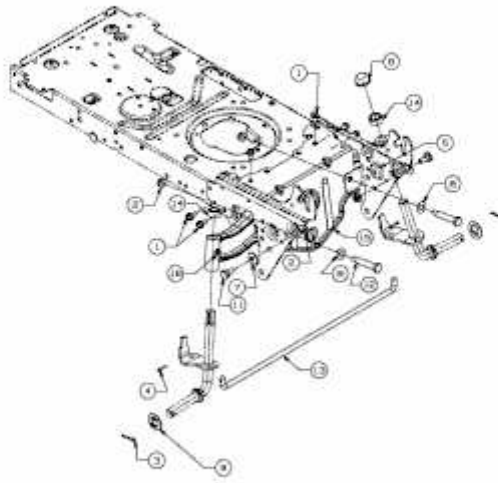

E3-05050C-02