

ab 11.02.2014
from 11.02.2014
à partir du 11.02.2014

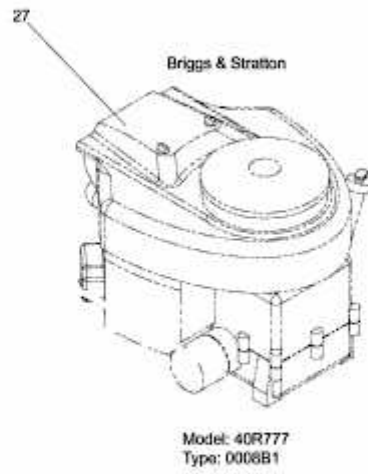

E3-02471A-02