

ab 03.03.2014
from 03.03.2014
à partir du 03.03.2014

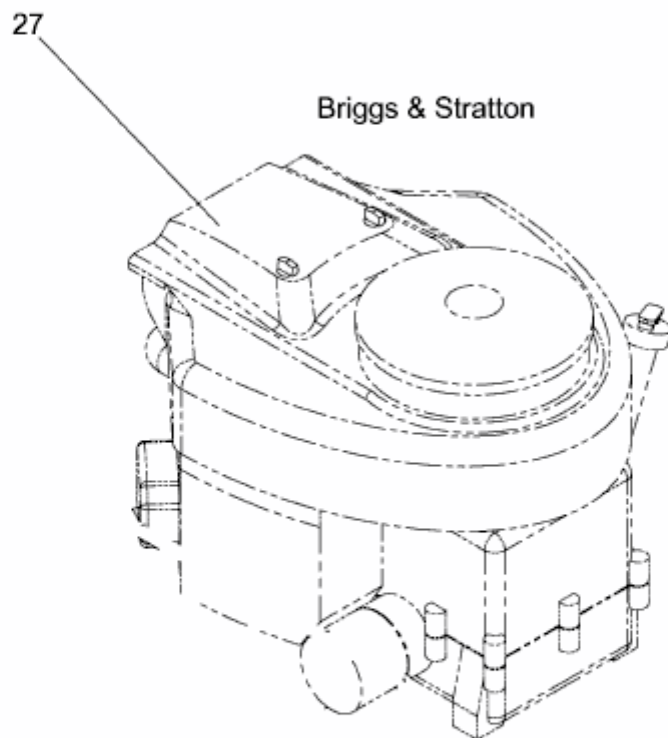

Model: 40R777
Type: 0008B1

E3-02471A-01