

GG 202 > 13HT763G607 (2015) > GESCHWINDIGKEITSREGELUNG

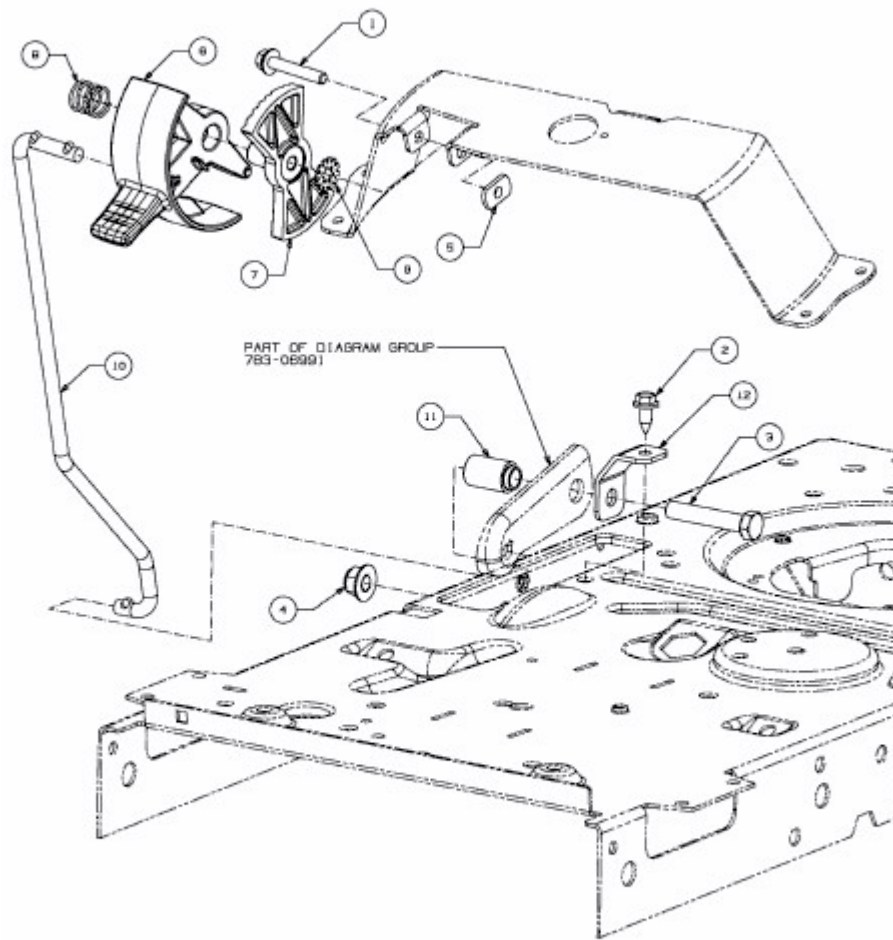

E3-07438B-01