

ab 17.02.2014
from 17.02.2014
à partir du 17.02.2014

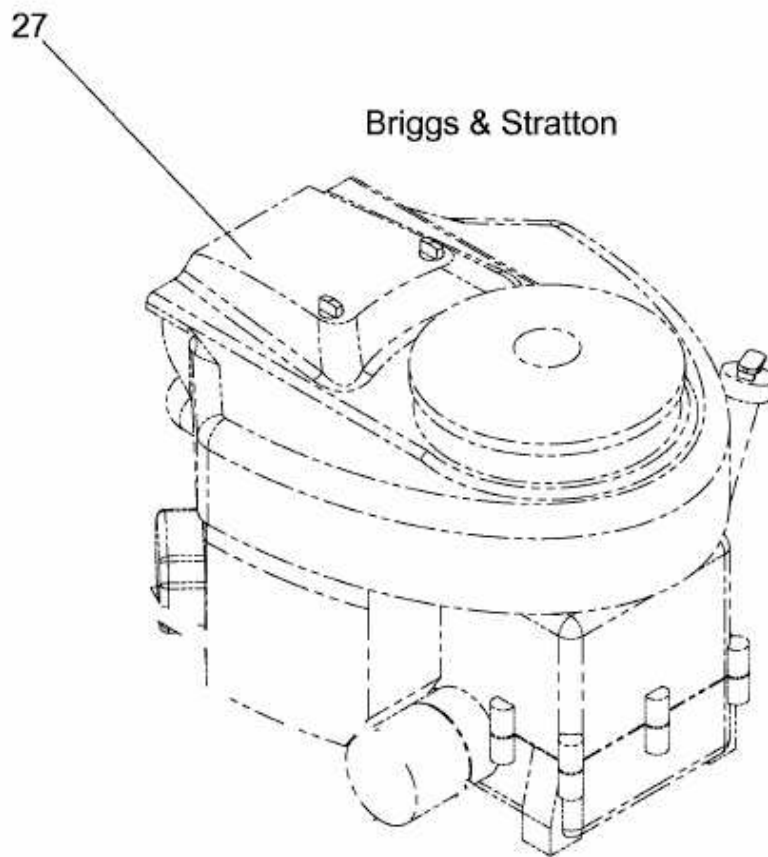

Model: 40R777
Type: 0008B1

E3-02471A-04