

ab 13.01.2015
from 13.01.2015
à partir du 13.01.2015

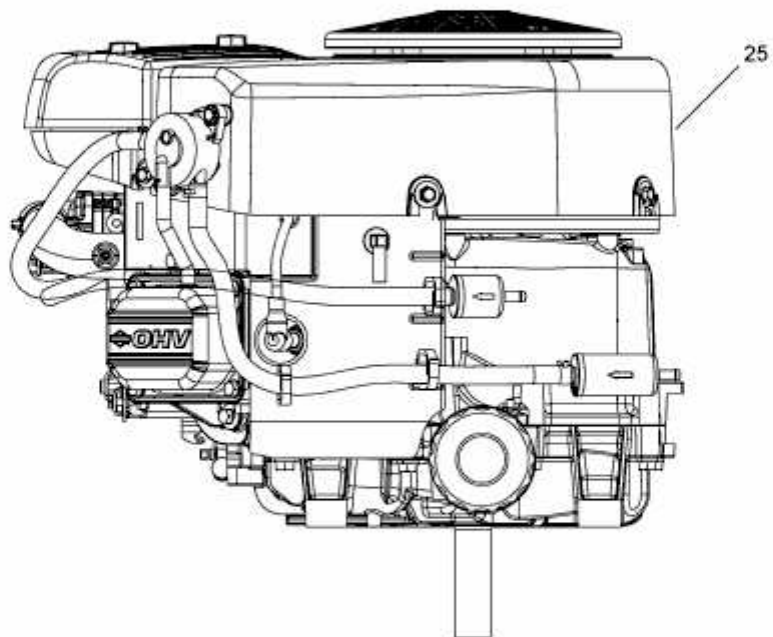

Briggs & Stratton
Model: 40R777
Type: 0019B1

E3-09062A-01