

ab 01.02.2016
from 01.02.2016
à partir du 01.02.2016

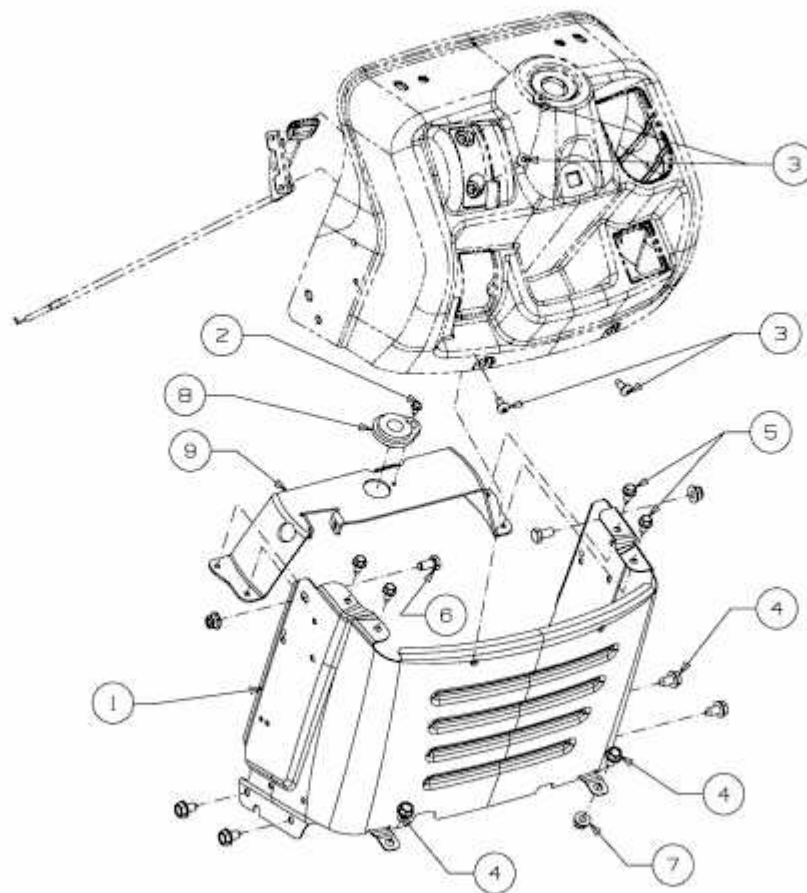

E3-09679A-01