

ab 16.01.2015  
from 16.01.2015  
à partir du 16.01.2015

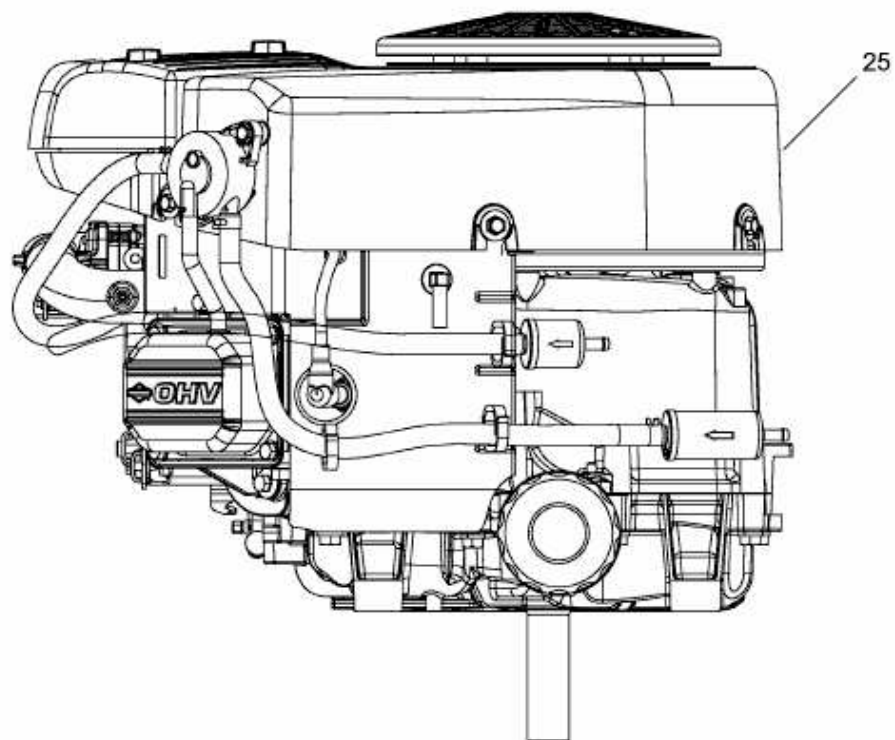

Briggs & Stratton  
Model: 40R777  
Type: 0019B1

E3-09062A-03