

ab 01.03.2014  
from 01.03.2014  
à partir du 01.03.2014

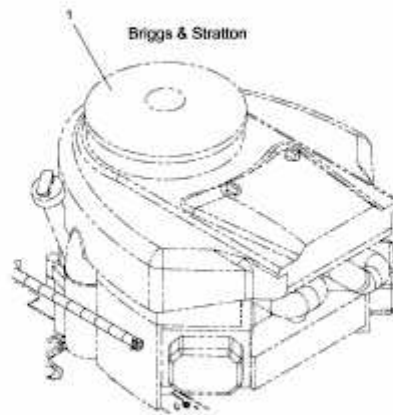

Model: 40R677  
Type: 0004B1

E3-02473A-01