

bis 16.12.2015
to 16.12.2015
jusqu'au 16.12.2015

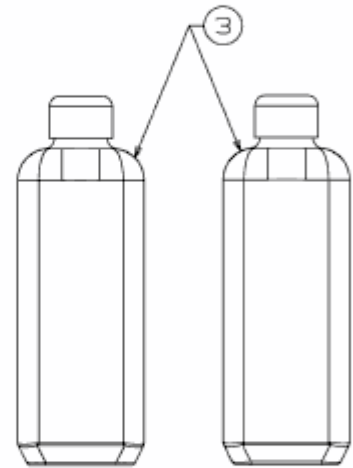
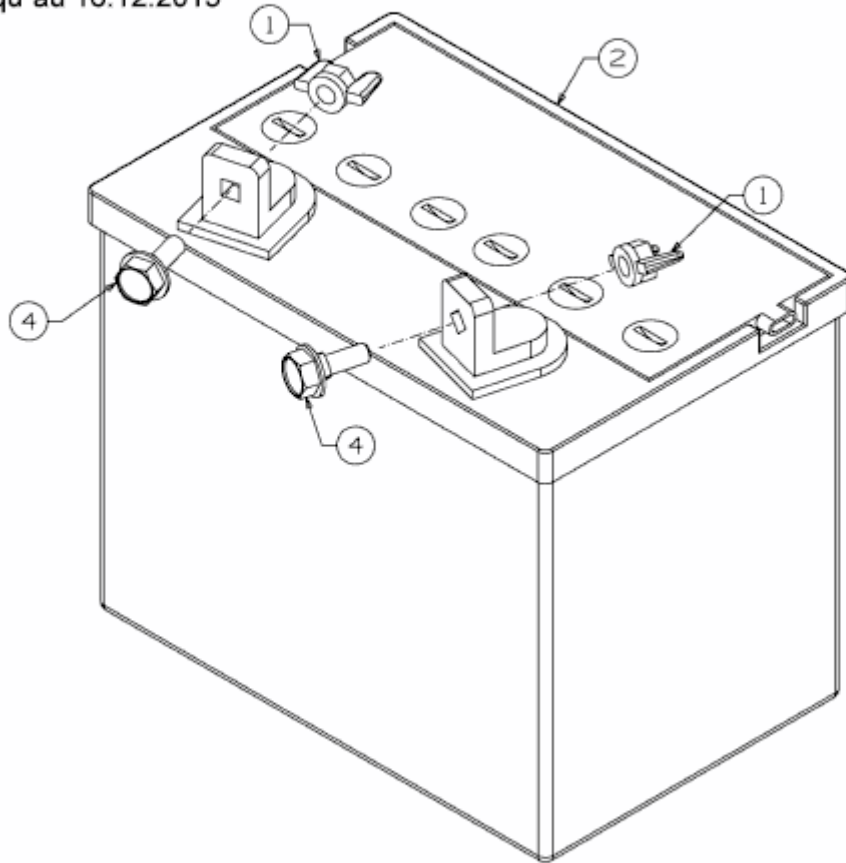

E3-07963B-02