

9

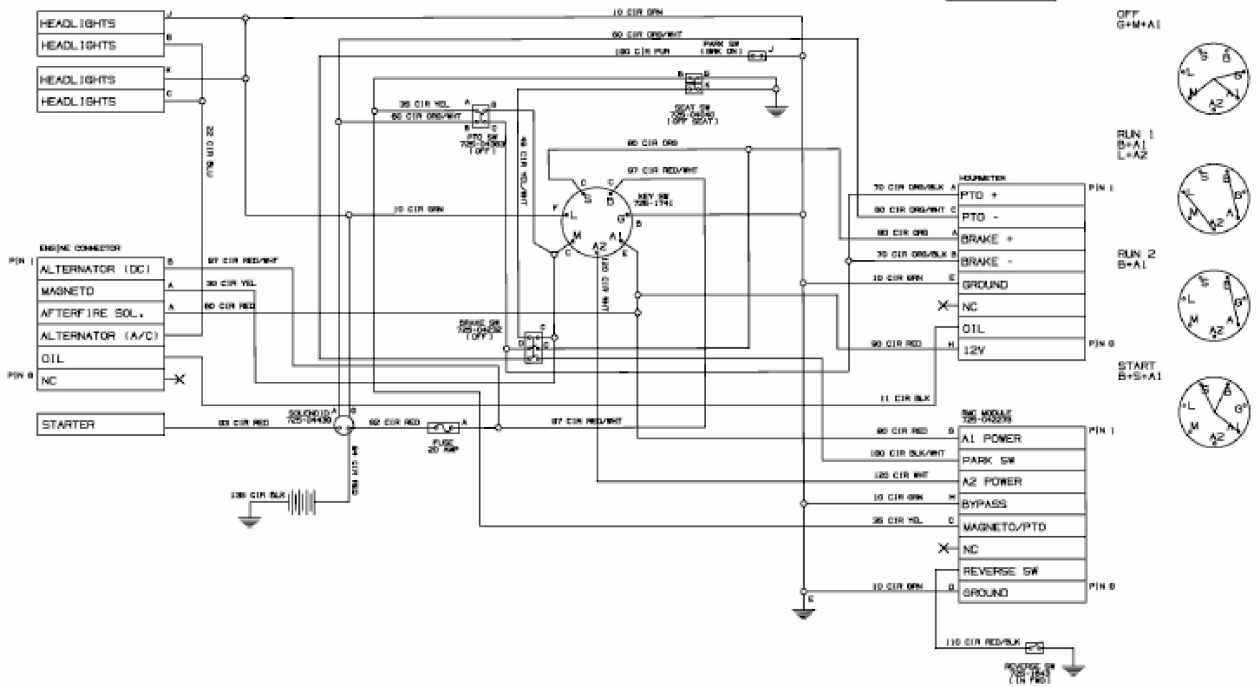

E3-02855A-02