

ab 10.12.2014
from 10.12.2014
à partir du 10.12.2014

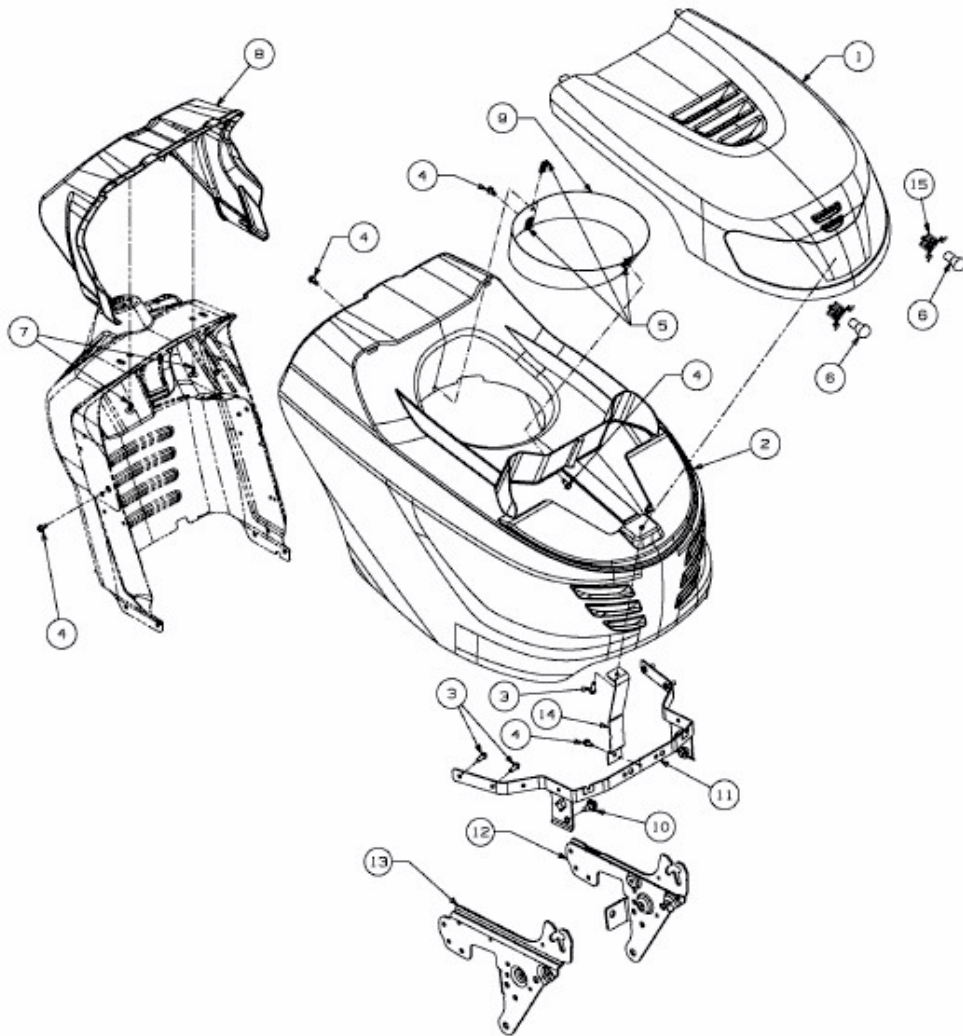

E3-09147A-01