

ab 01.02.2015
from 01.02.2015
à partir du 01.02.2015

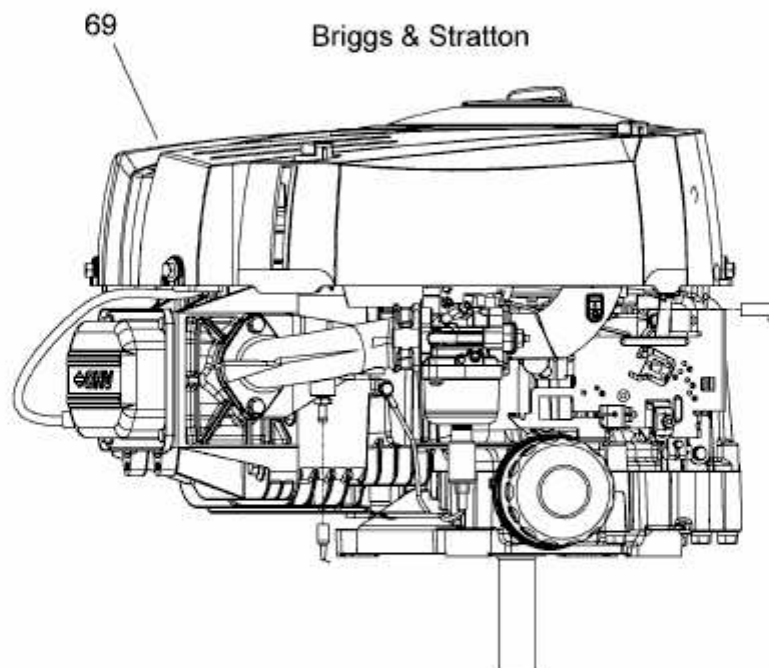

Model: 31R707
Type: 0035B1

E3-09127A-02