

GG 175 > 13HN763G607 (2014) > GESCHWINDIGKEITSREGELUNG

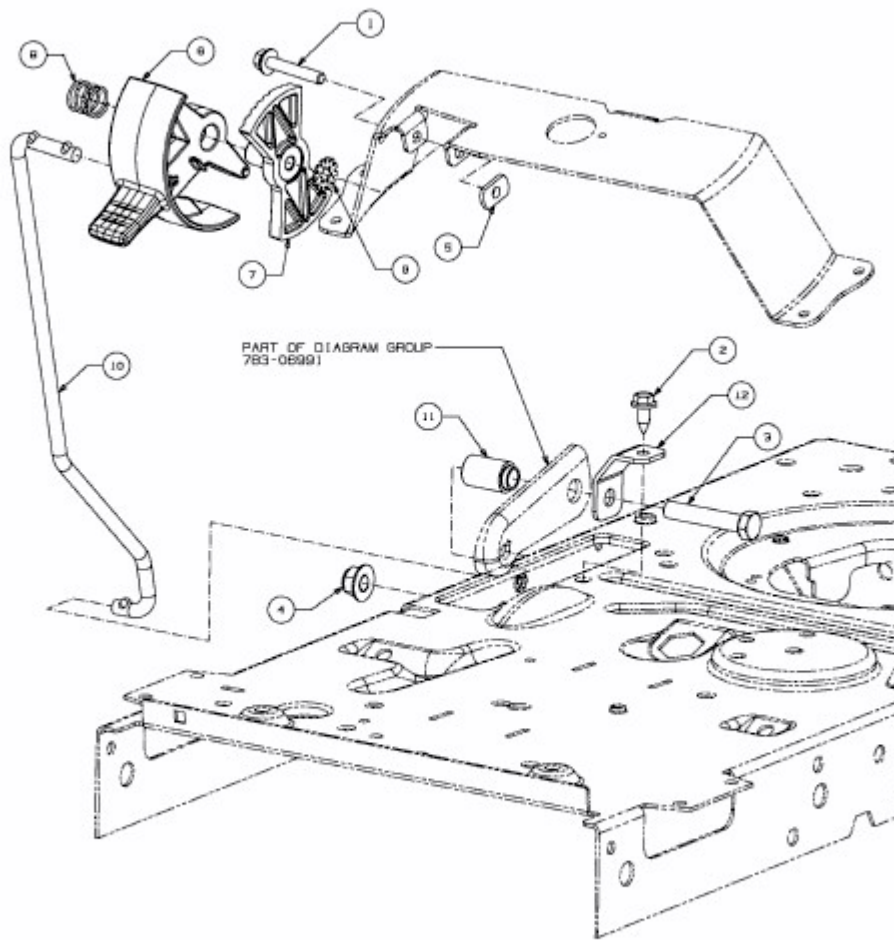

E3-07438B-01