

GL 15.5/92 H > 13HM99GE640 (2016) > SITZTRÄGER

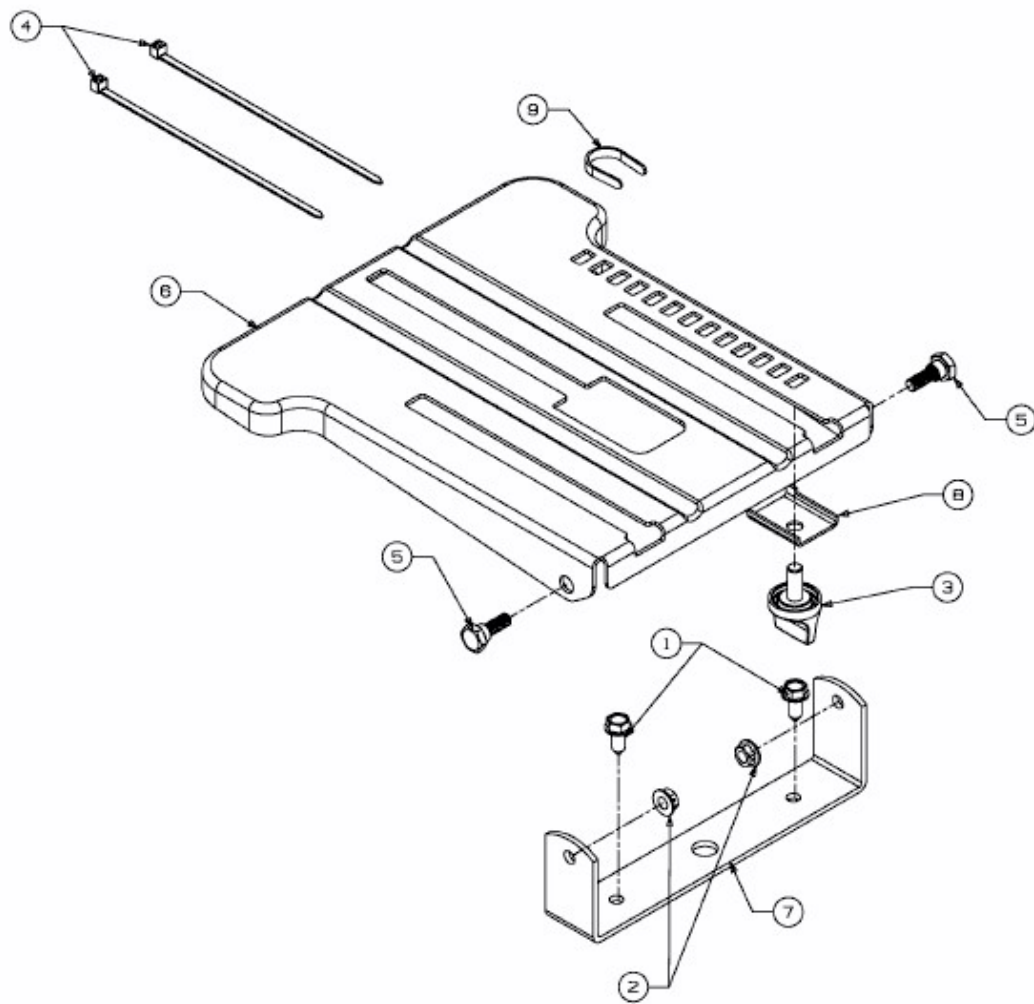

E3-07521B-01