

ab 19.01.2015
from 19.01.2015
à partir du 19.01.2015

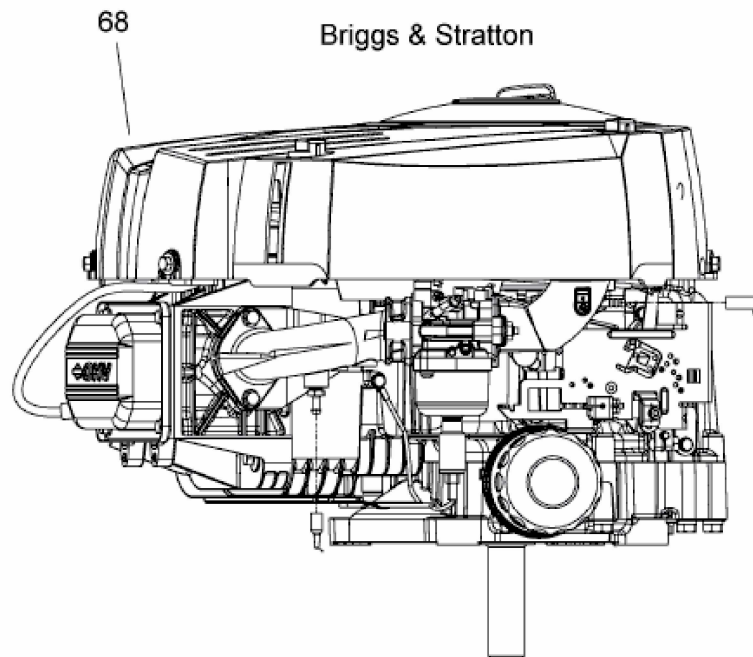

Model: 31R507
Type: 0029B1

E3-09121A-03