

RT 155-92 H > 13HM77TE694 (2016) > GESCHWINDIGKEITSREGELUNG

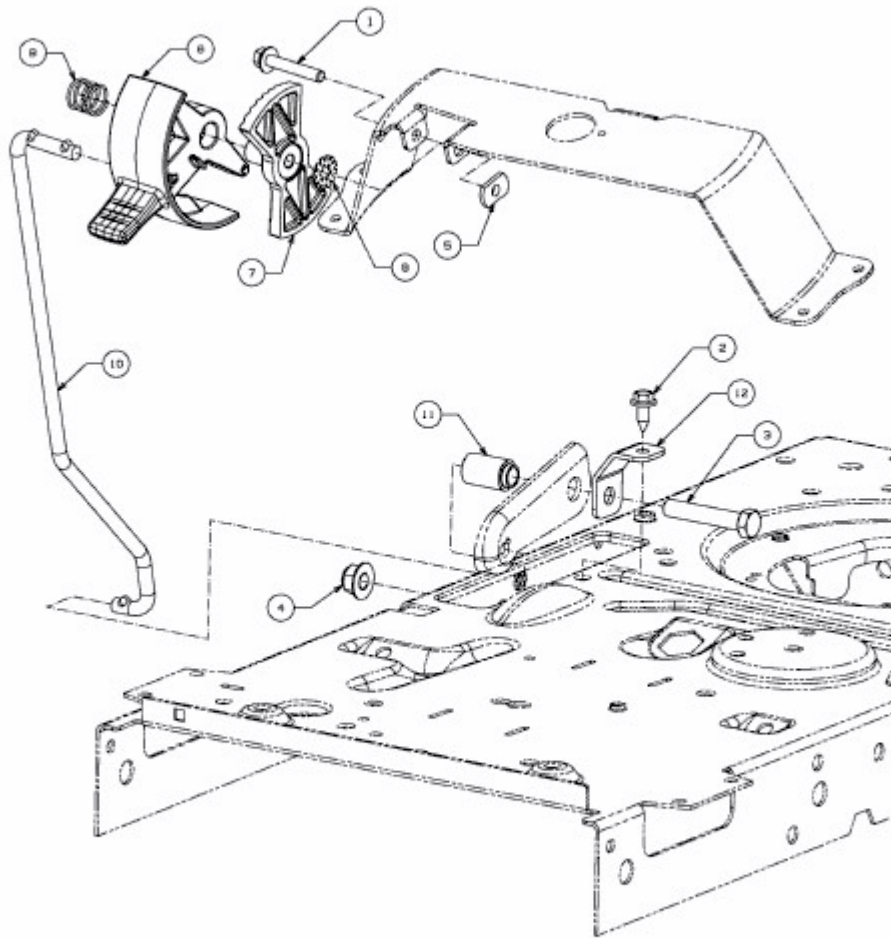

E3-07427B-01