

MASTERCUT 92-155 BIS 2016 > 13HM771E659 (2015) > GETRIEBE

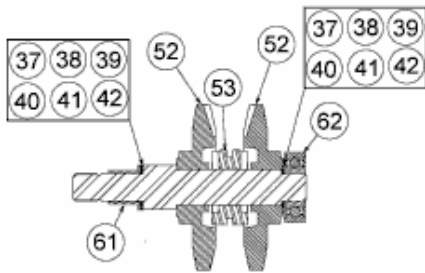

max. Axialspiel
max. axial backlash
max. jeu sur l'axe
0,004° - 0.008°

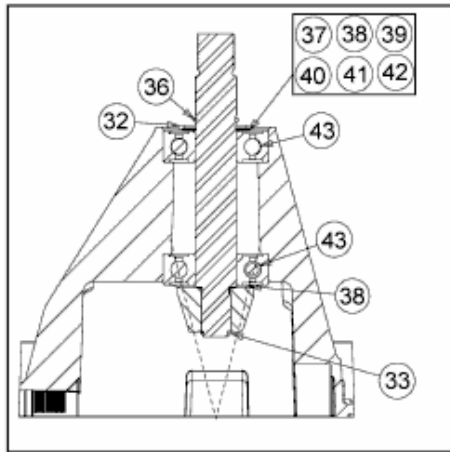
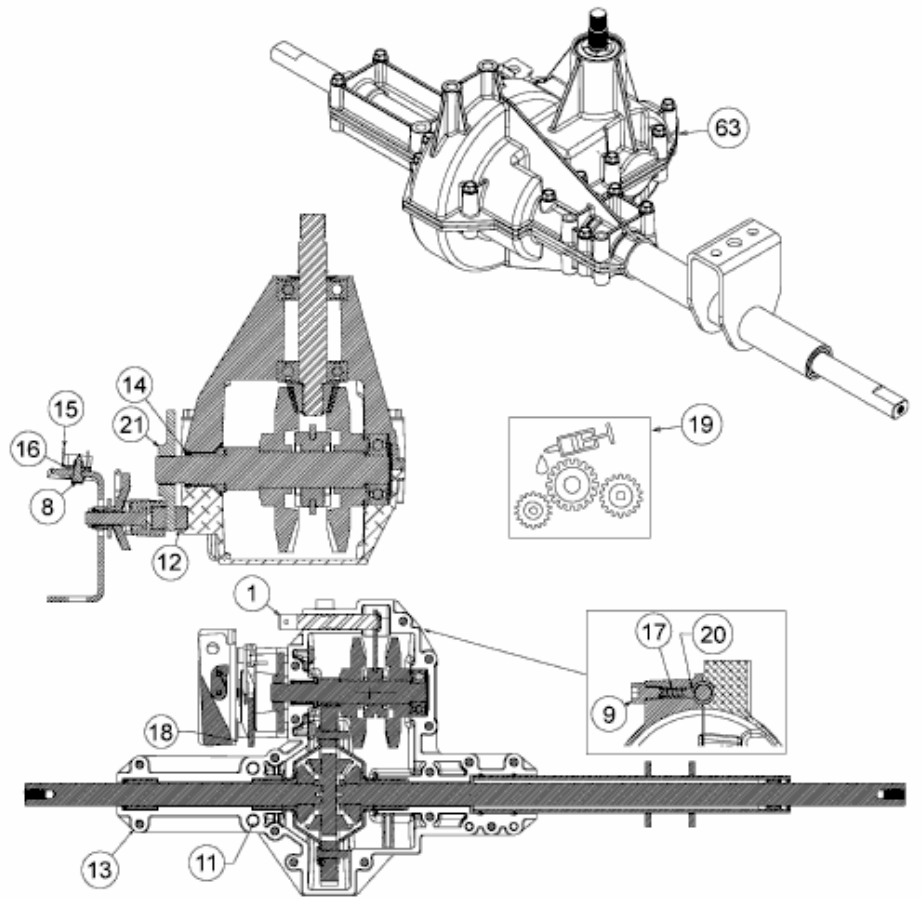

E3-03859F-02