

SMART RN 145 > 13HM76KN600 (2017) > RAHMEN

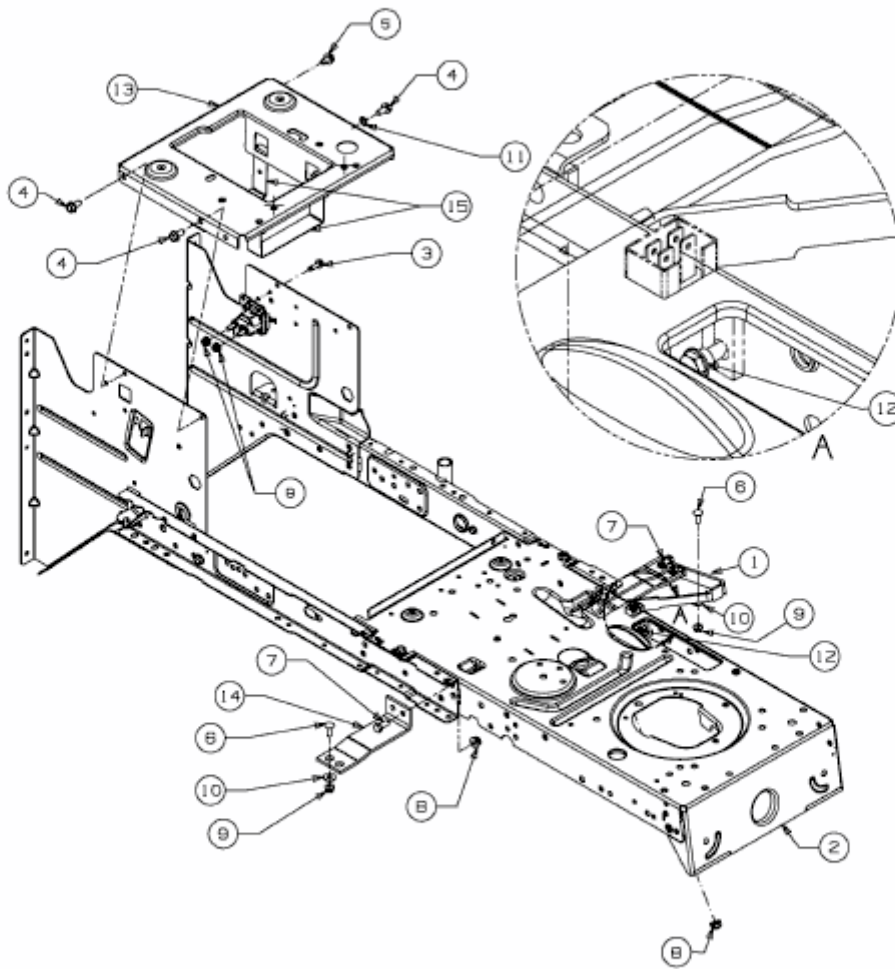

E3-04369E-01