

SMART RN 145 > 13HM76KN600 (2017) > SITZTRÄGER

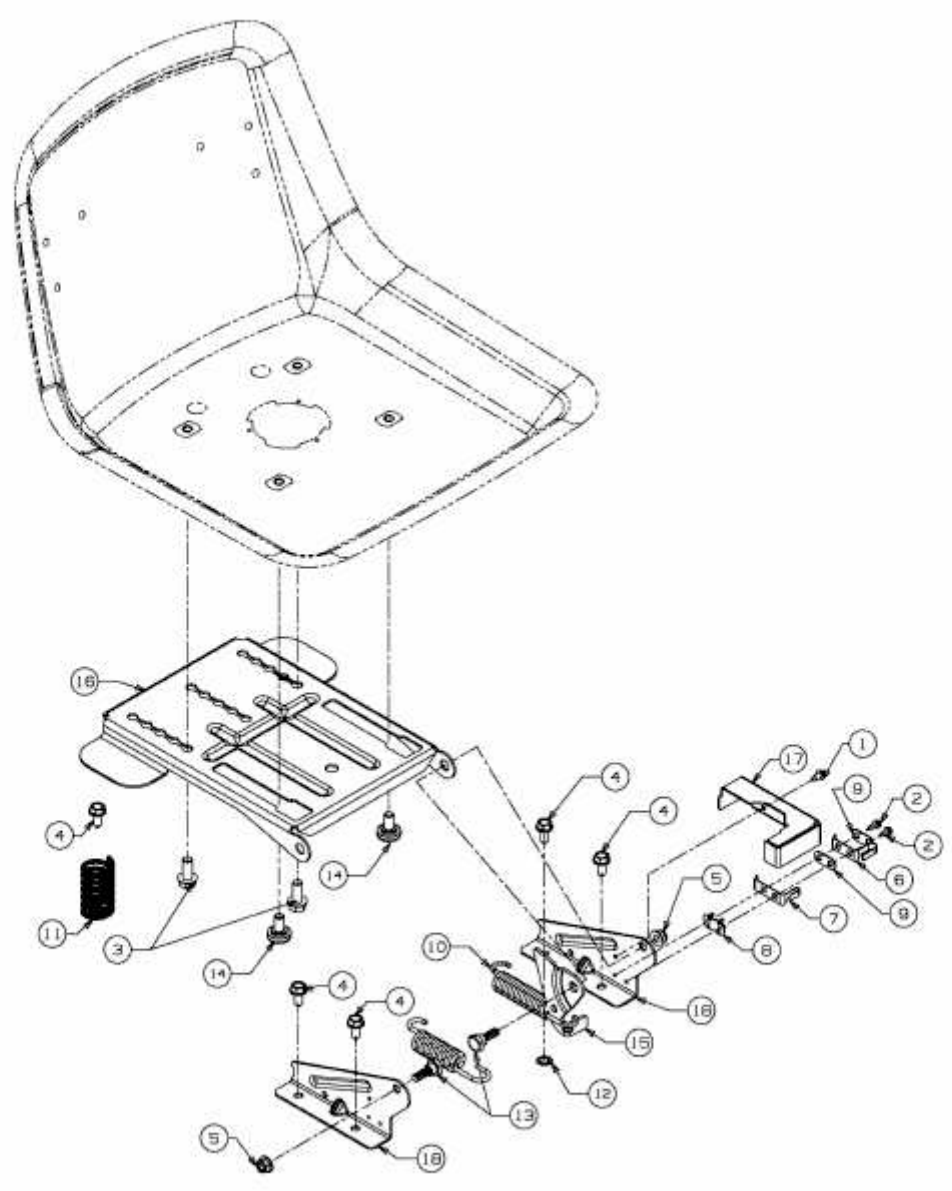

E3-02482B-01